

Quadro

The IP PBXs

QuadroM32x

QuadroM26xi

QuadroM26x

QuadroM12Li

QuadroM8L



Manual I:

Installation Guide

for QuadroM8L; QuadroM12Li; QuadroM26x; QuadroM26xi; QuadroM32x

Copyright and Trademarks

Copyright © 2003-2014 Epygi Technologies, Ltd. All Rights Reserved. Quadro is a registered trademark of Epygi Technologies, Ltd. Microsoft, Windows, and the Windows logo are registered trademarks of Microsoft Corporation. All other trademarks and brand names are the property of their respective proprietors.

Limited Warranty

Epygi Technologies, Ltd. ("Epygi") warrants to the original end-user purchaser every Quadro to be free from physical defects in material and workmanship under normal use for a period of one (1) year from the date of purchase (proof of purchase required) or two (2) years from the date of purchase (proof of purchase required) for products purchased in the European Union (EU). If Epygi receives notice of such defects, Epygi will, at its discretion, either repair or replace products that prove to be defective.

This warranty shall not apply to defects caused by (i) failure to follow Epygi's installation, operation or maintenance instructions; (ii) external power sources such as a power line, telephone line, or connected equipment; (iii) products that have been serviced or modified by a party other than Epygi or an authorized Epygi service center; (iv) products that have had their original manufacturer's serial numbers altered, defaced, or deleted; (v) damage due to lightning, fire, flood, or other acts of God.

In no event shall Epygi's liability exceed the price paid for the product from direct, indirect, special, incidental, or consequential damages resulting from the use of the product, its accompanying software, or its documentation. Epygi offers no refunds for its products. Epygi makes no warranty or representation, expressed, implied, or statutory, with respect to its products or the contents or use of this documentation and all accompanying software, and specifically disclaims its quality, performance, merchantability, or fitness for any particular purpose.

Return Policy

If the product proves to be defective during this warranty period, call Epygi Customer Support at (972) 692-1166 to obtain a Return Material Authorization (RMA) Number. Registered users also may access Epygi's Technical Support (www.epygi.com; "Support") to send their RMA request. For Brazil representatives, call (21) 2518-3161 or contact via Web (www.saga.com.br). Please have your proof of purchase on hand when contacting us. When returning a product, mark the Return Authorization Number clearly on the outside of the package and include your original proof of purchase. Return requests cannot be processed without proof of purchase. Customers are responsible for shipping and handling charges when shipping to Epygi.

Epygi or its service center will use commercially reasonable efforts to ship a replacement product within ten (10) working days after receipt of the returned product. Actual delivery times may vary depending on customer location.

Epygi reserves the right to revise or update its products, pricing, software, or documentation without obligation to notify any individual or entity. Please direct all inquiries to:

Epygi Technologies, Ltd., Two Legacy Town Center, 1400 Preston Road, Suite 300, Plano, Texas 75093

Representative in Brazil - Saga Sistemas e Computadores SA, Av. Rio Branco, 18 - 8 andar, Rio de Janeiro 20090-001

Notice to Users

This Installation Guide, in whole or in part, may not be reproduced, translated, or reduced to any machine-readable form without prior written approval.

Epygi provides no warranty with regard to this Installation Guide or other information contained herein and hereby expressly disclaims any implied warranties of merchantability or fitness for any particular purpose in regard to this manual or other such information. In no event shall Epygi be liable for any incidental, consequential, or special damages, whether based on tort, contract, or otherwise, arising out of or in connection with this manual or other information contained herein or the use thereof.

Administrative Council for Terminal Attachments (ACTA) Customer Information

This equipment complies with Part 68 of the FCC rules and the requirements adopted by the ACTA. On the back of this equipment is a label that contains, among other information, a product identifier in the format US:AAAEQ###TXXXX, made out to HX7OT00BHX70100. If requested, this number must be provided to the telephone company.

Any plug or jack that is used to connect this equipment to the premises wiring and telephone network must comply with the applicable FCC Part 68 rules and requirements adopted by the ATCA.

The Ringer Equivalence Number is an indicator of the maximum number of devices allowed for connection to a telephone interface. The termination on an interface may consist of any combination of devices subject only to the requirements that the sum of the RENs of all the devices does not exceed five. Excessive RENs on a telephone line may result in the devices not ringing in response to an incoming line. The REN for this product is part of the product identifier that has the format US:AAAEQ###TXXX, made out to HX7OT00BHX70100. The digits represented by ### are the REN without a decimal point (in this case 00B is a REN of 0.0B.)

If the Quadro causes harm to the telephone network, the telephone company will notify you in advance that a temporary discontinuance of service may be required. But if advance notice isn't practical, the telephone company will notify the customer as soon as possible. Also, you will be advised of your right to file a complaint with the FCC if you believe it is necessary.

The telephone company may make changes in its facilities, equipment, operations or procedures that could affect the operation of the equipment. If this happens, the telephone company will provide advance notice for you to make the necessary modifications to maintain uninterrupted service.

Connection to a party line service is subject to state tariffs. Contact the state public utility commission, public service commission or the corporation commission for information.

If your home has specially wired alarm equipment connected to the telephone line, ensure the installation of the Quadro does not disable your alarm equipment. If you have any questions about what will disable alarm equipment, consult your telephone company or a qualified installer.

Electrical Safety Advisory

To reduce the risk of damaging power surges, we recommend you install an AC surge arrester in the AC outlet from which the Quadro is powered.

Industry Canada Statement

This product meets the applicable Industry Canada technical specifications.

Safety Information

Before using the Quadro, please review and ensure the following safety instructions are adhered to:

- To prevent fire or shock hazard, do not expose your Quadro to rain or moisture.
- To avoid electrical shock, do not open the Quadro. Refer servicing to qualified personnel only.
- Never install wiring during a lightning storm.
- Never install telephone jacks in wet locations unless the jack is specified for wet locations.
- Never touch uninsulated telephone wire or terminals unless the telephone line has been disconnected at the network interface.
- Use caution when installing or modifying cable or telephone lines.
- Avoid using your Quadro during an electrical storm.
- Do not use your Quadro or telephone to report a gas leak in the vicinity of the leak.
- An electrical outlet should be as close as possible to the unit and easily accessible.

Emergency Services

The Quadro SIP Service is intended to function as a secondary telephone service. This service is made available through the Internet and therefore is dependent upon a constant source of electricity and network availability. If a power outage occurs, the Quadro SIP Service automatically will be disabled. User understands in the event of a power or network outage, the Quadro SIP Service will not support 911 emergency services, and further, such services only will be available via the user's regular telephone line that is not connected to the Quadro. User further acknowledges that any interruption in the supply or delivery of electricity or network availability is beyond Epygi's control and Epygi shall have no responsibility for losses arising from such interruption.

Table of Contents

Manual I: Installation Guide

About This Installation Guide	6
Requirements	7
Hardware Overview	8
The Connectors Panel of QuadroM32x/8L/26x/12Li/26xi	8
QuadroM32x/8L/26x/12Li/26xi's Front Panel LEDs	12
Step 1: Installing the Quadro	14
Networking Overview	14
LAN/WAN Connection Options	15
Connecting the Hardware	20
Step 2: Configuring the Quadro	26
Step 2.1: Logging in to Quadro	27
Step 2.2: System Configuration Wizard	28
System Configuration	28
DHCP Settings for the LAN Interface	29
Regional Settings	29
Emergency and PSTN Access Code Settings	30
Finishing the System Configuration Wizard	31
Step 2.3: Internet Configuration Wizard	33
Uplink Configuration	34
WAN IP Configuration	35
PPP/PPTP Configuration	36
WAN Interface Configuration	37
DNS Settings	37
Finishing the Internet Configuration Wizard	38
Step 2-A: Using IP Lines	39
Supported SIP Phones	42
Step 2-B: Using Receptionist	44
Step 2-C: Using ISDN Lines	45
Step 2-D: Configuring the E1/T1 Settings	51
Editing the E1/T1 Trunk	52
Signaling Type CCS	53
Signaling Type CAS	59
Step 3: Registering on Epygi's Technical Support	67
Appendix: Changing the Admin Password	68
Appendix: Configuring NAT Traversal	70
Appendix: Registering on Epygi's SIP Server	72
Appendix: Checking the Connections	77
Appendix: Pin Assignment of ISDN	79

Appendix: Pin Assignment of E1/T1 80
Appendix: Pin Assignment of RJ21 81

Manual II: see Administrator's Guide

This guide describes in detail the menus available for administrators only. Furthermore, it includes all the system's default values at a glance.

Manual III: see Extension User's Guide

This guide describes in detail the menus available for extension users. Furthermore, it includes all the call codes at a glance.

About This Installation Guide

This Installation Guide explains the installation of the QuadroM IP PBX. It gives step-by-step instructions to provision the QuadroM and configure the phone extensions. After successfully configuring the Quadro, a user will be able to make SIP and local PBX calls, as well as calls to the PSTN and access the Internet from devices connected to the LAN.

- **QuadroM8L** offers 8 phone line (FXO), 2 phone extensions (FXS), 1 Ethernet WAN port and 1 Ethernet LAN port
- **QuadroM26x** offers 8 phone line (FXO), 26 phone extensions (FXS), 1 Ethernet WAN port and 1 Ethernet LAN port
- **QuadroM12Li** supports 6 phone line (ISDN), 2 phone extensions (FXS), 1 Ethernet WAN port and 1 Ethernet LAN port
- **QuadroM26xi** supports 6 phone line (ISDN), 26 phone extensions (FXS), 1 Ethernet WAN port and 1 Ethernet LAN port
- **QuadroM32x** offers one phone line (E1/T1), 2 phone extensions (FXS), 1 Ethernet WAN port, 1 Ethernet LAN port and 1 ETH port.

This Installation Guide does not provide advanced configuration information. For these features, refer to the Administrator's and Extension User's Guides.

[Step 1: Installing the Quadro](#) explains the connection of cables and devices to the Quadro.

[Step 2: Configuring the Quadro](#) describes the configuration steps necessary to integrate the Quadro into your network environment.

[Step 2-A: Using IP Lines](#) explains how to configure IP lines on the QuadroM IP PBX and to connect IP phones.

[Step 2-B: Using Receptionist](#) refers to the document describing Receptionist's configuration on the Quadro.

[Step 2-C: Using ISDN Lines](#) explains how to configure ISDN trunks and to define a default outgoing MSN.

[Step 2-D: Configuring the E1/T1 Settings](#) describes the basic E1/T1 settings.

[Step 3: Registering on Epygi's Technical Support](#) shows you how to access the Epygi Technical Support Center and the Epygi SIP Server.

[Appendix: Changing the Admin Password](#) explains how to change the default administrator password.

[Appendix: Configuring NAT Traversal](#) explains configuration of the Quadro if it is placed behind a NAT enabled router.

[Appendix: Registering on Epygi's SIP Server](#) explains how to register on Epygi's powerful SIP server.

[Appendix: Checking the Connections](#) gives hints on solving common problems.

Requirements

- One 120/240 VAC power outlet in close proximity to the Quadro.
- One RJ45 Ethernet 10/100 broadband Internet connection.
- For QuadroM32x one E1/T1 cable to connect the Quadro with the CO or PBX.
- At least one off-the-shelf analog phone with an RJ11 telephone cable.
- For QuadroM26x/26xi RJ21 connector (F) with cable and distributed panel.
- At least one IP phone with CAT5 cable with RJ45 connector.
- One CAT 5 Ethernet cable with RJ45 connector to connect to the Quadro's LAN port.
- One PC with a 10/100 Mbps Ethernet card or adapter installed.
- TCP/IP network protocol installed on each PC.
- Internet Explorer, Netscape Navigator, Mozilla Firefox or Opera browser is recommended.

Please Note: The QuadroM32x/8L/26x IP PBX is shipped with one RJ11 cable and one straight RJ45 CAT 5 cable. The QuadroM12Li/26xi IP PBX is shipped with one straight RJ45 CAT 5 cable. If the LAN connector of the Quadro connects to a hub or switch, a crossover cable may be required.

Other cables are added according to the different connectivity requirements of the QuadroM IP PBX types.

Hardware Overview

The Connectors Panel of QuadroM32x/8L/26x/12Li/26xi

The illustration below includes the connector's panel of QuadroM.



Fig. I-1: QuadroM8L's Connectors Panel



Fig. I-2: QuadroM26x's Connectors Panel



Fig. I-3: QuadroM Back Power Panel

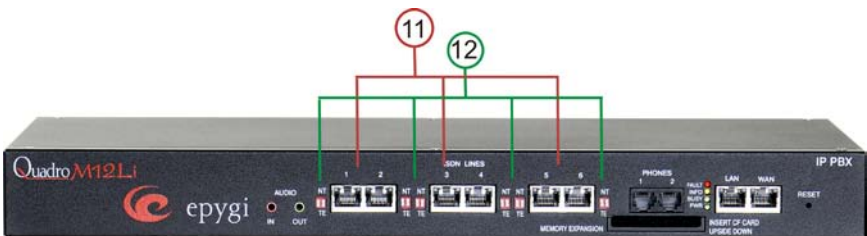

Fig. I-4: QuadroM12Li's Connectors Panel



Fig. I-5: QuadroM32x's Connectors Panel

- 1 For QuadroM8L/26x/12Li/26xi AUDIO IN connector connects Quadro to the radio or any other audio resource to be used for the hold music.
- 2 For QuadroM8L/26x/12Li/26xi AUDIO OUT connector is used for Paging service. The Paging Group service is used to page a group of extensions by forcing extensions to go off-hook and opening one-way communication. The service is particularly used for announcements addressed to a group of extensions. Service allows to page multiple extensions by dialing the Paging Group extension.

Please Note: The Paging Group service requires called extensions to use one of the following SIP or analog phones which are able to automatically go off-hook:

- snom 190
- snom 200
- snom 220
- snom 300
- snom 320
- snom 360
- snom 370
- snom 710
- snom 720
- snom 760
- snom 820
- snom 870
- snom MeetingPoint
- Aastra 480i
- Aastra 480iCT
- Aastra 9112i
- Aastra 9133i
- Aastra 9143i(33i)
- Aastra 9480i(35i)
- Grandstream GXP2120
- Grandstream GXP2124
- Grandstream GXP2200
- Grandstream GXV3140
- Grandstream GXV3175
- Polycom SoundPoint IP 300SIP
- Polycom SoundPoint IP 330SIP
- Polycom SoundPoint IP 331SIP
- Polycom SoundPoint IP 335SIP
- Polycom SoundPoint IP 450SIP
- Polycom SoundPoint IP 501SIP
- Polycom SoundPoint IP 550SIP
- Polycom SoundPoint IP 601SIP
- Polycom SoundPoint IP 650SIP
- Polycom SoundStation IP 6000
- Polycom VVX 300/310
- Polycom VVX 400/410
- Polycom VVX 1500
- Linksys SPA921

- Aastra 9480iCT
- Aastra 6751i
- Aastra 6753i
- Aastra 6755i
- Aastra 6757i
- Aastra 6757iCT
- Aastra 6730i
- Aastra 6731i
- Aastra 6735i
- Aastra 6737i
- Aastra 6739i
- Aastra 480e (analog phone)
- Thomson ST2030S
- Grandstream BT200
- Grandstream GXP1400
- Grandstream GXP1405
- Grandstream GXP1450
- Grandstream GXP2000
- Grandstream GXP2100
- Grandstream GXP2110
- Linksys SPA922
- Linksys SPA941
- Linksys SPA942
- Linksys SPA2002
- Linksys SPAPAP2T
- Yealink SIP-T20P
- Yealink SIP-T22P
- Yealink SIP-T26P
- Yealink SIP-T28P
- Yealink SIP-T32G
- Yealink SIP-T38G
- Yealink SIP-T46G
- AudioCodes 310HD
- AudioCodes 320HD
- Panasonic KX-UT136
- Panasonic KX-UT123
- Panasonic KX-TGP550T04
- Alcatel Temporis IP200
- Alcatel Temporis IP600
- Alcatel Temporis IP800

Attention: Call paging will not work if the called extension is in call.

- 3** The Reset button may be used in two ways: (1) to initiate a normal reset or (2) to carry out a factory reset. A normal reset is executed by pressing the Reset button with a paper clip for an instant. Pressing the reset button and holding it down for seven seconds or more will execute a factory reset. This will restore the factory defaults and clear all settings including the IP address and the administration password you entered.

Please Note: A Factory Reset forces the default LAN IP address of 172.30.0.1 and default admin password of 19.

- 4** LINE sockets to connect the Quadro to the PSTN network using standard analog phone service. These are FXO (Foreign Exchange Office) analog ports.
- 5** PHONE sockets with RJ11 connectors enable connectivity of regular analog telephones. These are FXS (Foreign Exchange Station) analog ports.

In the event of a power failure, PHONE 1 is connected to LINE 8, allowing the phone to send/receive phone calls directly to the PSTN network. PHONE 1 is powered by the PSTN.

Attention: Only LINE 1 is connected to PHONE 8 during a power failure. The other LINE and PHONE ports are not connected together.

- 6 LAN RJ45 socket to attach to the IP phones in the Quadro's Local Area Network (LAN) via an Ethernet CAT 5 cable. For connecting multiple IP phones, a switch is used.
- 7 WAN RJ45 socket to attach the Internet Uplink (WAN) via an Ethernet CAT 5 cable.
- 8 The CF socket enables connectivity of Compact Flash memory providing expansion for additional voice mails and record data.

Attention: Power down the Quadro before inserting/removing the Compact Flash memory card.

- 9 The TELCO (50-pin connector) socket with RJ21 M connector enables up to 24 additional analog LINEs (3-26) support. This is an FXS analog ports expansion.
- 10 Power supply socket to connect a power cable.
- 11 ISDN sockets to connect the Quadro to the ISDN network termination units to use PSTN services. A straight Ethernet CAT 5 cable can be used with an RJ45 connector according to the ISDN Pin assignment, see [Appendix: Pin Assignment of ISDN](#).
- 12 The NT/TE switches are used to control the QuadroM12Li/26xi device on the S/T Bus. If the QuadroM12Li/26xi is connected to the beginning or end of the S/T Bus or if there is only one ISDN unit connected to the S/T Bus, then this switch should be toggled to the NT (Network Terminator) position. Otherwise, if the QuadroM12Li/26xi is connected in the middle of the S/T Bus, the switch should be toggled to the TE (Terminal Endpoint) position.

S/T Bus is a full-duplex interface. It consists of two groups (one for transmit and the other one for receive) of two-wire interface and might support multiple devices (up to 8 devices can be attached to the S/T Bus). Both ends of each of the two-wire interfaces should be terminated (100ohm resistance is present at both ends of each two-wire interface).

Please Note: If the trunks on the QuadroM12Li/26xi have incorrect NT/TE position, they may not function properly, including connection establishment permanent failure.

- 13 RJ-45 socket to attach the E1/T1 trunk. See [Appendix: Pin Assignment of E1/T1](#).
- 14 ETH RJ45 socket to attach the PC in the Quadro's Local Area Network (LAN). If a PC is connected directly to this socket, a straight Ethernet CAT 5 cable is used.

QuadroM32x/8L/26x/12Li/26xi's Front Panel LEDs



Fig. I-6: QuadroM32x's Front Panel LEDs

1.	POWER green Status of the Power Supply	on: power supply ok off: no power supply or device is still booting
2.	Busy green Status of CPU	off: no power on or blinking: normal activity
3.	Info yellow System information	on: device is booting off: no information blinking: an event occurred; details specified in the System Event section of the Management interface
4.	Fault red System status	on either an error or the device is booting off: no error blinking: system unusable
5.	WAN green Status of the WAN interface	on: link ok off: no link flickering: traffic on the link
6.	LAN green Status of the LAN interface	on: link ok off: no link flickering: traffic on the link
QuadroM12Li/26xi's Additional Front Panel LEDs		
7.	Green LED for ISDN Trunks 1-6	ISDN Link Status
		on: ISDN link is UP, Frame Synchronization is OK off: - In passive mode ISDN link status is not informative. - In non passive mode ISDN link is not connected or ISDN trunks are stopped from GUI
8.	Orange LED for ISDN Trunks 1-6	Power Source Status on ISDN Network Mode
		on: Power Source checkbox is selected from GUI on Network Mode and some type of ISDN devices (ISDN Phones, etc.) can receive power from Quadro off: Power Source checkbox is not selected from GUI
QuadroM32x's Additional Front Panel LEDs		
9.	ETH green Status of the ETH interface	on: link ok off: no link flickering: traffic on the link
10.	E1/T1 green Status of the E1/T1 trunk	on: frame synchronization is ok off: frame synchronization is not ok or link is down

LED indication during a firmware update

A firmware update is indicated by the red (**Fault**) and yellow (**Info**) LEDs. Both will blink simultaneously for about two minutes while the firmware is being updated. The Quadro will then reboot automatically showing the boot LED sequence.

LED indication during a boot sequence

A boot sequence is indicated as follows: The red **Fault** LED will glow for a few seconds, then the yellow **Info** LED will glow for another four or five minutes while the green **Busy** LED is blinking. Once the **Info** LED is off, the boot sequence has been completed successfully.

LED indication during emergency firmware upload

The red **Fault** LED and the yellow **Busy** LEDs will stop blinking alternately and start blinking in parallel. This shows that Quadro has accepted the emergency firmware and is loading it. After a few seconds, Quadro will boot, indicated as follows: The red **Fault** LED will glow for a few seconds, then the yellow **Info** LED will glow for another few seconds while the green **Busy** LED is jittering. When the yellow **Info** LED extinguishes, the boot sequence has been completed successfully.

Step 1: Installing the Quadro

Networking Overview

To establish a connection between the Internet and your local area network (LAN), an access router is needed. The QuadroM IP PBX can serve, among other functions, as an access router and will perform the task of connecting your LAN, or a group of one or more PCs, to the wide area network (WAN) or the Internet. The Quadro will process and regulate the data traffic between these two networks.

The Quadro is a device with two sides: one side connects to your LAN, and the other side connects to the Internet, or to the WAN. Quadro's firewall and Network Address Translation (NAT) functionality protects your LAN from being seen from the Internet side making the LAN private and secure.

Both Ethernet WAN and LAN ports transmit up to 100 Mbps traffic.

Every device within an IP network requires a unique IP address to identify itself. Since the Quadro connects to both the LAN and the WAN, it has to be part of both networks, and must have two IP addresses: one for the WAN side and one for the LAN side. The Quadro's integrated firewall/NAT functionality will hide the LAN IP address from the WAN (Internet) side.

There are two ways of assigning an IP address: statically or dynamically.

A Static IP address is a fixed, manually assigned IP address that remains valid until changed. If you plan to use the Quadro as your Internet access router, contact your Internet Service Provider (ISP) to find out if a static IP address is assigned to your account. If so, you will need this static IP address when configuring the Quadro device.

A dynamic IP address is a temporary address that is automatically assigned by your ISP and will change periodically. If your ISP offers a dynamic IP address, the Quadro will act as a DHCP client and will receive a new IP address from the ISP's DHCP server or PPPoE feature.

Please Note: A DHCP client is a piece of software that requests an IP address from a DHCP server. A DHCP server assigns on request a unique IP address to a device. The Quadro, like many routers, acts as a DHCP client on its WAN interface and as a DHCP server on its LAN interface.

The Quadro must be visible to the Internet to be able to receive and send VoIP calls. When the Quadro is placed in a private network, typically behind existing routers, it will by default attempt to pass through the NAT of this router with its STUN (Simple Traversal of UDP over NAT) feature. STUN will work without user configuration with the majority of basic routers. In some scenarios, port forwarding on the router is required to make the Quadro accessible to other Quadro devices and the Epygi SIP Server on the Internet. Another configuration option is to use the Quadro as the Internet access router, connected directly to the WAN, eliminating the traverse to the local NAT firewall.

LAN/WAN Connection Options

- A QuadroM32x IP PBX with an Ethernet WAN port behind a router, which is connected to a cable or xDSL modem. IP phones are placed on the WAN side of the QuadroM32x.

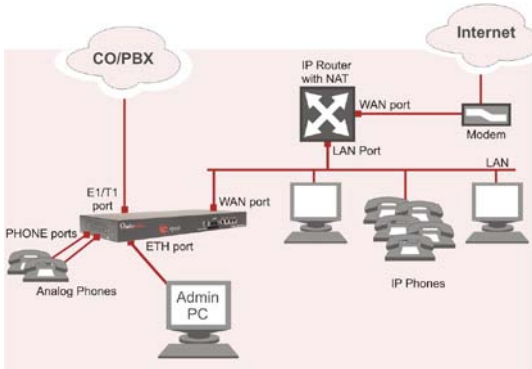

Fig. I-7: Configuration: QuadroM32x behind a router with IP phones on WAN

- A QuadroM8L/26x IP PBX with an Ethernet WAN port behind a router, which is connected to a cable or xDSL modem. IP phones are placed on the WAN side of the QuadroM8L/26x.

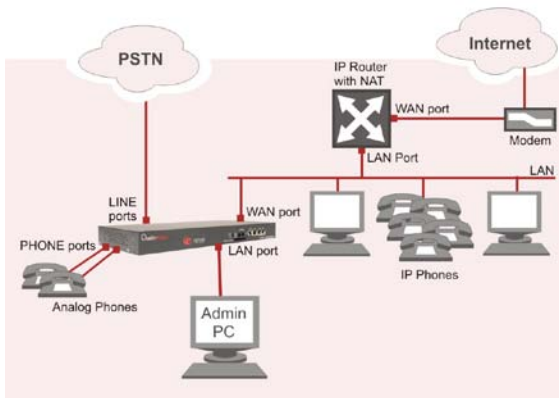

Fig. I-8: Configuration: QuadroM8L/26x behind a router with IP phones on WAN

In this and the following configuration, the IP router typically acts as a DHCP server for the LAN and assigns the IP addresses to the PCs and other devices. The Quadro can be connected through its WAN port directly to one of the router's LAN ports and will get an IP address from the router. By default, the Quadro acts as a DHCP client on the WAN port. The IP phones are placed on the WAN side of the QuadroM8L/26x, connected to the company LAN.

The Admin PC can be connected to the Quadro LAN or WAN port to access the Web Management of the Quadro.

Please Note: Since Quadro uses STUN by default, it will work with most basic routers without any further configuration.

- A QuadroM12Li/26xi with an Ethernet WAN port behind a router, which is connected to a cable or xDSL modem. IP phones are placed on the WAN side of the QuadroM12Li/26xi.

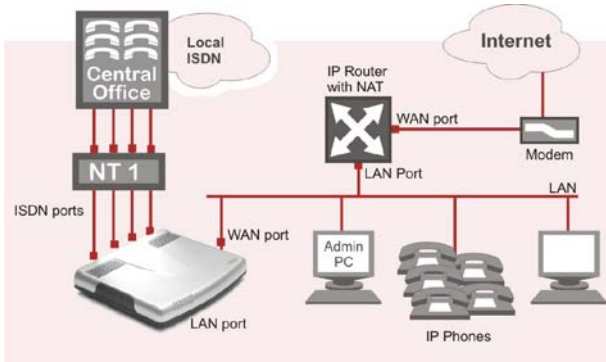

Fig. I-9: Configuration: QuadroM12Li/26xi behind a router with IP phones on WAN

- A QuadroM32x IP PBX with an Ethernet WAN port behind a router, which is connected to a cable or xDSL modem. IP phones are placed on the LAN side of the QuadroM32x.

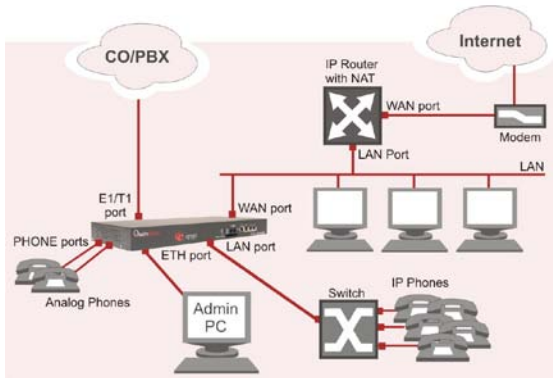

Fig. I-10: Configuration: QuadroM32x behind a router with IP phones on LAN

- A QuadroM8L/26x IP PBX with an Ethernet WAN port behind a router, which is connected to a cable or xDSL modem. IP phones are placed on the LAN side of the QuadroM8L/26x.

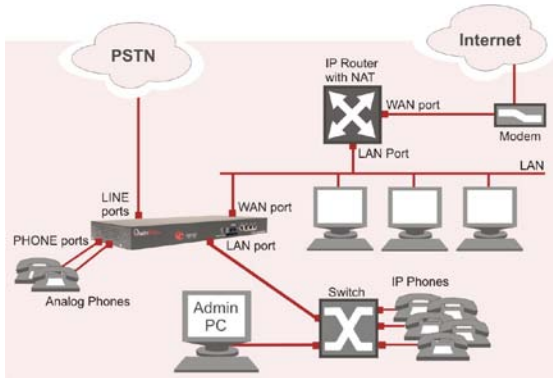

Fig. I-11: Configuration: QuadroM8L/26x behind a router with IP phones on LAN

This configuration is identical to the previous configuration, with the difference that IP phones are connected to the LAN port of the QuadroM. The QuadroM can be configured as a DHCP server to provide the network parameters to the devices on its LAN.

- **A QuadroM12Li/26xi with an Ethernet WAN port behind a router, which is connected to a cable or xDSL modem. IP phones are placed on the LAN side of the QuadroM12Li/26xi.**

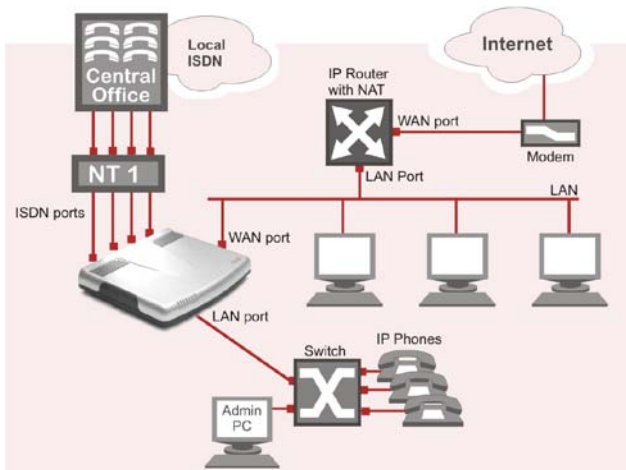

Fig. I-12: Configuration: QuadroM12Li/26xi behind a router with IP phones on LAN

- **A QuadroM32x IP PBX used as an Internet Access Router, connected directly to the Internet.**

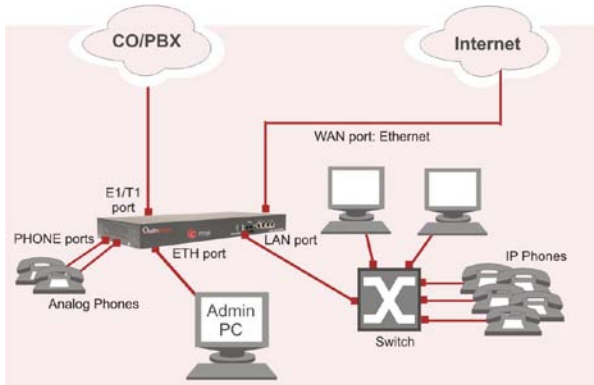

Fig. I-13: Configuration: QuadroM32x used as Internet Access Router

The Admin PC is connected to the Quadro ETH port or WAN port to access the Web Management of the Quadro.

- **A QuadroM8L/26x IP PBX used as an Internet Access Router, connected directly to the Internet.**

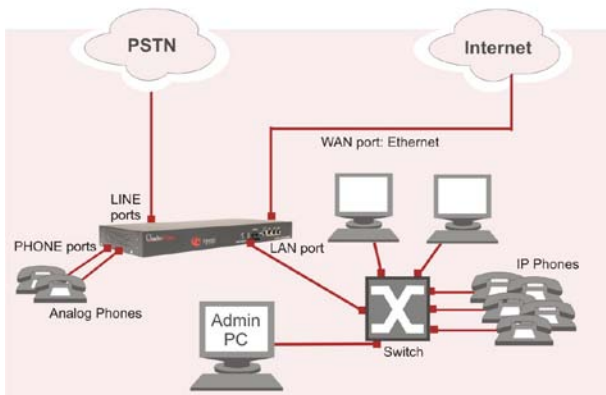

Fig. I-14: Configuration: QuadroM8L/26x used as Internet Access Router

- **A QuadroM12Li/26xi used as an Internet Access Router, connected directly to the Internet.**

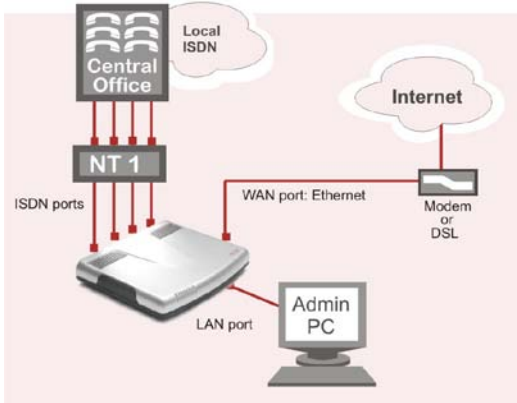

Fig. I-15: Configuration: QuadroM12Li/26xi used as Internet Access Router

Please Note: The Admin PC is connected to the Quadro's LAN port through a switch/hub to access the Web Management of the QuadroM. It is recommended to have Admin PC acting as a DHCP client and obtaining IP address from the Quadro.

Connecting the Hardware

- **QuadroM32x behind a router with IP phones connected to WAN**

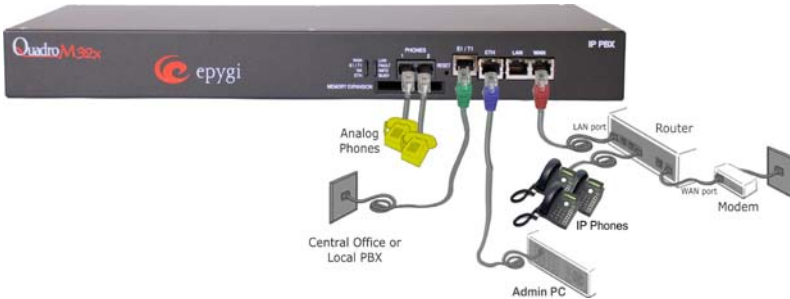

Fig. I-16: Installation: QuadroM32x behind a router with IP phones on WAN

- **QuadroM8L/26x behind a router with IP phones connected to WAN**

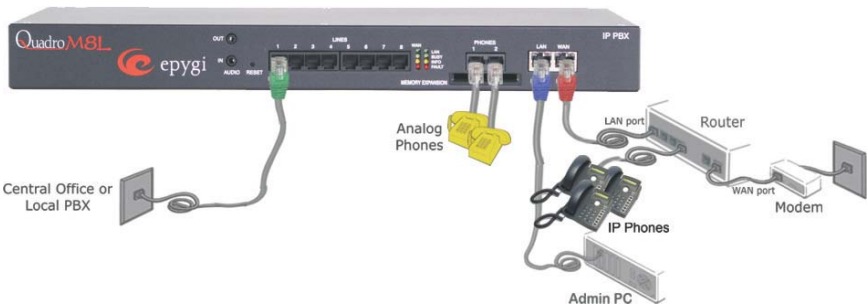

Fig. I-17: Installation: QuadroM8L/26x behind a router with IP phones on WAN

- **QuadroM12Li/26xi behind a router with IP phones connected to WAN**

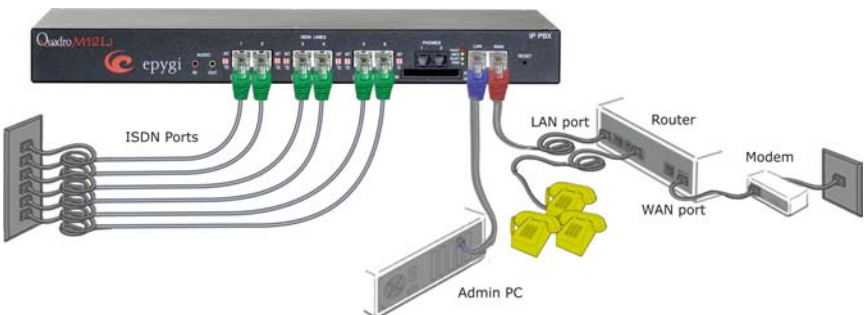

Fig. I-18: Installation: QuadroM12Li/26xi behind a router with IP phones on WAN

- **QuadroM32x behind a router with IP phones connected to LAN**

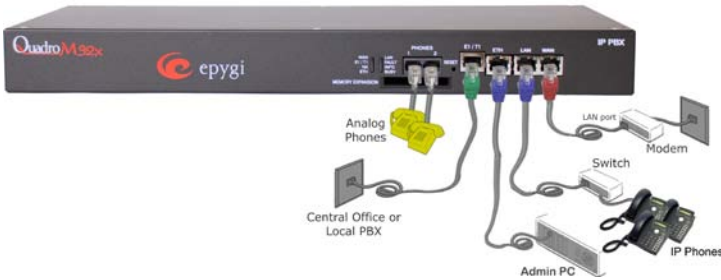

Fig. I-19: Installation: QuadroM32x behind a router with IP phones on LAN

- **QuadroM8L/26x behind a router with IP phones connected to LAN**



Fig. I-20: Installation: QuadroM8L/26x behind a router with IP phones on LAN

- **QuadroM12Li/26xi behind a router with IP phones connected to LAN**

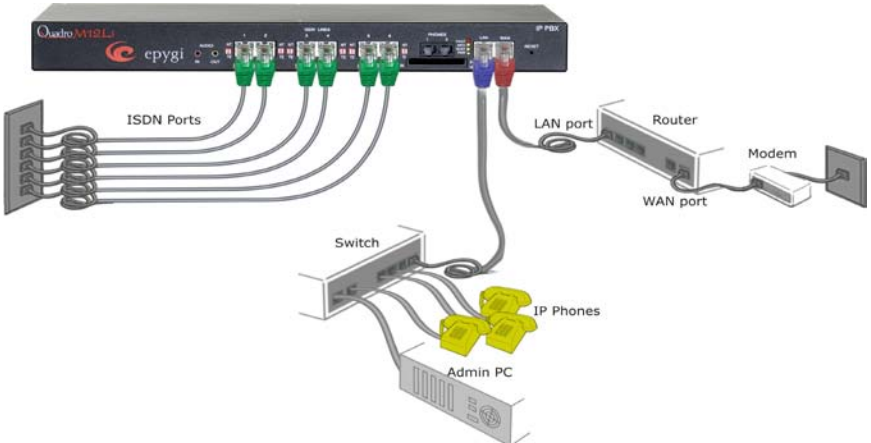

Fig. I-21: Installation: QuadroM12Li/26xi behind a router with IP phones on LAN

- **QuadroM32x used as Internet access router**

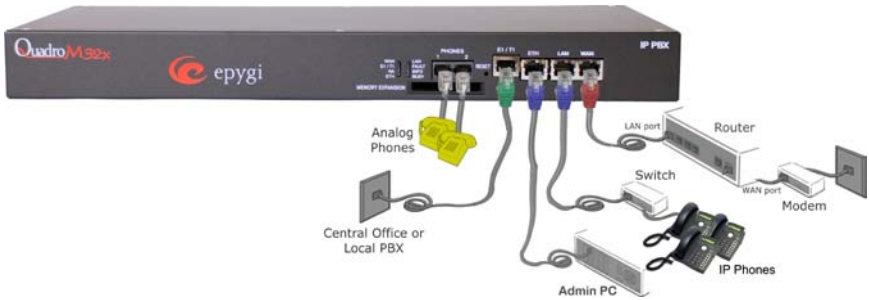

Fig. I-22: Installation: QuadroM32x used as an Internet Access Router

- **QuadroM8L/26x used as Internet access router**

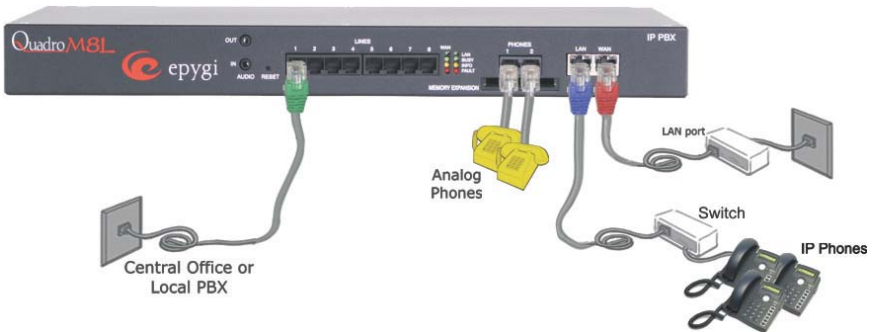

Fig. I-23: Installation: QuadroM8L/26x used as an Internet Access Router

- **QuadroM12Li/26xi used as Internet access router**

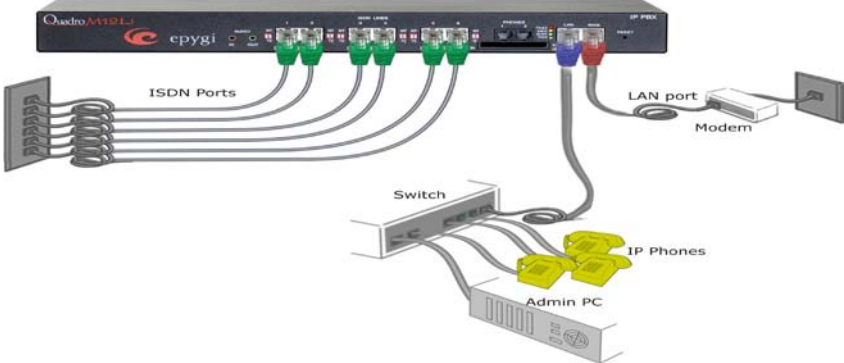

Fig. I-24: Installation: QuadroM12Li/26xi used as an Internet Access Router

- **QuadroM26x additional analog lines connections**

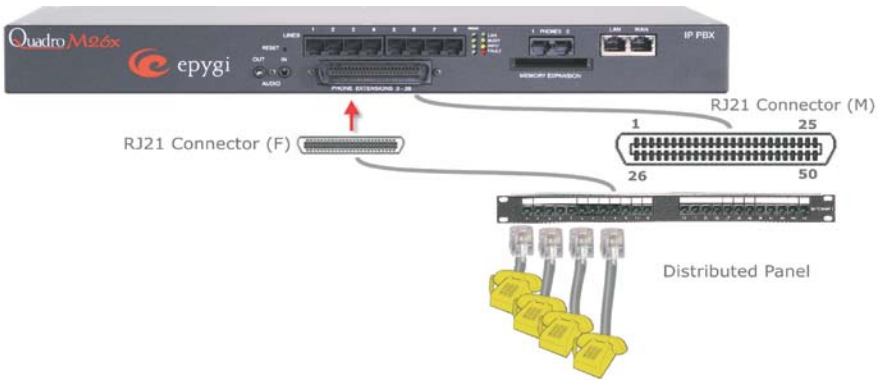

Fig. I-25: Installation: QuadroM26x connected via RJ21 connectors

- **QuadroM26xi additional analog lines connections**

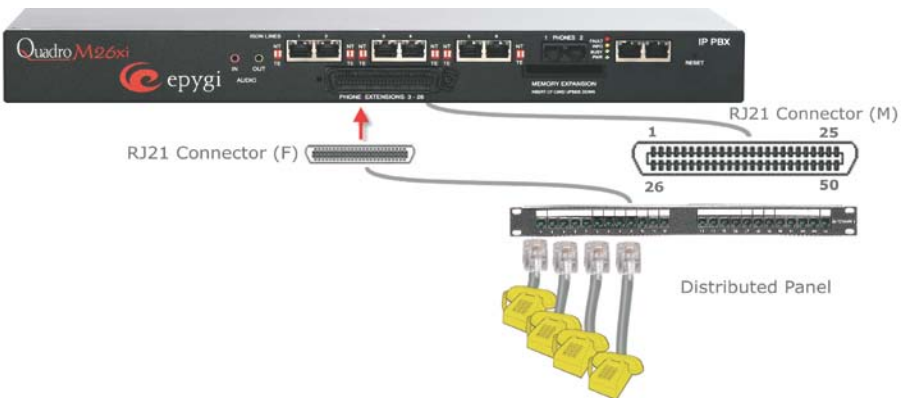

Fig. I-26: Installation: QuadroM26xi connected via RJ21 connectors

OR a multi-cable (RJ21 – RJ11) connection can be applied instead.

Wires are presented in the table below:

Color	Pin (Tip)	Pin (Ring)	Color	FXS Port
White/Blue	26	1	Blue/White	3
White/Orange	27	2	Orange/White	4
White/Green	28	3	Green/White	5
White/Brown	29	4	Brown/White	6
White/Slate	30	5	Slate/White	7
Red/Blue	31	6	Blue/Red	8
Red/Orange	32	7	Orange/Red	9
Red/Green	33	8	Green/Red	10
Red/Brown	34	9	Brown/Red	11
Red/Slate	35	10	Slate/Red	12
Black/Blue	36	11	Blue/Black	13
Black/Orange	37	12	Orange/Black	14
Black/Green	38	13	Green/Black	15
Black/Brown	39	14	Brown/Black	16
Black/Slate	40	15	Slate/Black	17
Yellow/Blue	41	16	Blue/Yellow	18
Yellow/Orange	42	17	Orange/Yellow	19
Yellow/Green	43	18	Green/Yellow	20
Yellow/Brown	44	19	Brown/Yellow	21
Yellow/Slate	45	20	Slate/Yellow	22
Violet/Blue	46	21	Blue/Violet	23
Violet/Orange	47	22	Orange/Violet	24
Violet/Green	48	23	Green/Violet	25
Violet/Brown	49	24	Brown/Violet	26
Violet/Slate	50	25	Slate/Violet	Not Used

- Verify the product package contents are complete. Refer to the contents sheet included in the packaging to determine if all the items were shipped in the box.
- Before you connect the hardware, make sure that all devices are powered off.
- Connect analog phones to the PHONE ports on the Quadro's rear panel. You may connect up to two analog phones.
- Connect the E1/T1 port to your PBX or the trunk from the PSTN Central Office Only after configuring the E1/T1 settings according to the specifications of your PSTN provider (see [Appendix: Pin Assignment of E1/T1](#)).
- Connect the Ethernet port on your PC via a straight CAT 5 cable with an RJ45 connector to the LAN socket of the Quadro.
- Connect the IP phones to the switch and attach it to the LAN socket of the Quadro via a straight CAT 5 cable with an RJ45 connector.
- Connect the WAN port of the Quadro to the Internet service via a cable or DSL modem.
- Power up the DSL or Cable modem first.
- Connect the power cable to the POWER port on the back side of your QuadroM and plug the power plug into the power outlet.
The red LED (Fault) will glow for several seconds followed by the yellow LED (Info), which will glow for several minutes. When Info LED is off, the Quadro is operational.
- Power up any hub or switch followed by any PC and other devices on the LAN side.
- Check the LEDs: The green Busy LED must glow continuously. The green ETH, LAN and WAN LEDs will blink when cables are connected to these ports and all devices are powered up. If the green LAN and WAN LEDs do not blink, verify cabling and ensure that all devices are powered up.

Please Note: CAT 5 cables can be faulty without any visual indication. The LAN and WAN LEDs verify that the Ethernet connection is established between the end points. If these LEDs are not illuminated, there is a connection problem between the Quadro and the other device.

Step 2: Configuring the Quadro

Verify functionality of both IP and PSTN calls:

- **PSTN telephony:** If the Quadro is connected to the PSTN network via the E1/T1, FXO or ISDN interface, verify the functionality of PSTN calls:
 - Make an outbound PSTN call by dialing **9 + PSTN number**.
 - Arrange to receive an incoming call. The incoming PSTN calls will be routed to the Auto Attendant by default, and the caller has to enter a valid extension number, e.g., 101, followed by the # sign to reach a phone connected to the first PHONE port of the Quadro.
- **IP telephony:** Dial **899#** and you will hear a voice message that confirms you have successfully established an IP call. If this call is not successful, go to [Appendix: Checking the Connections](#) for troubleshooting.

You may customize the following settings by logging in to the Quadro's Web Management (see Step 2.1):

- **Bandwidth** - to regulate the number of calls allowed by the Quadro to avoid degradation in low bandwidth conditions.
- **Time/Date** - to ensure the correct time and time zone are used for call records.
- **Regional Settings** - if your Quadro is located outside the United States, it is important to properly configure your line connections to the PSTN in your location.
- **Firewall** - if your Quadro is connected behind a router with its own firewall service running, disable the firewall to make Quadro accessible for management purposes.

Step 2.1: Logging in to Quadro

- Start a browser (MS Internet Explorer, Netscape, Opera, Mozilla Firefox, etc.) on a PC connected to the QuadroM via the LAN or WAN interface.
- Since Firewall is disabled on the QuadroM by default, you may connect the Web GUI either from WAN or LAN side of the Quadro. To connect the Quadro's Web GUI from the WAN side, enter **http://Quadro_WAN_IP** (IP address assigned by the company's DHCP server) in the address field of your browser. If the PC is connected to the Quadro's LAN side, enter **http://172.30.0.1** (Quadro's default LAN IP address) in the address field of your browser.
- The **Login** page of the Quadro will be displayed (see Fig. I-27).

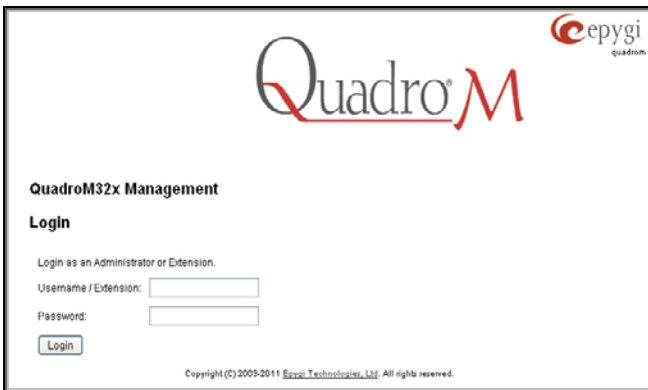

Fig. I-27: Login page

Enter **admin** as the Username and **19** as the password to log in as the administrator. Once you log in, you will enter into the Quadro Management Menu.

Please Note: If you consecutively enter a wrong password and/or username for five times the device will be unavailable for login for five minutes.

After log in, the **Quadro Management** page will be displayed.

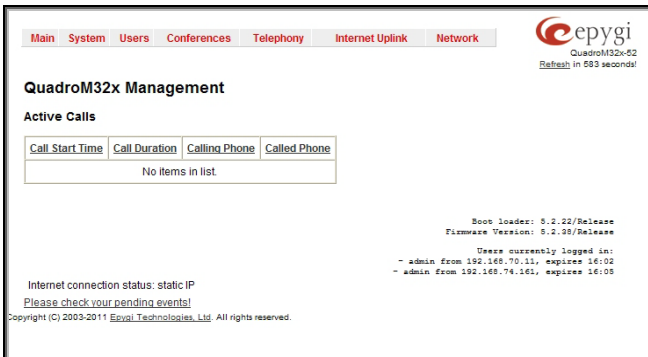

Fig. I-28: QuadroM Management page

Step 2.2: System Configuration Wizard

Select the **System Configuration Wizard** from the **System** menu. The **System Configuration Wizard** is a tool for the administrator to define the Quadro's Local Area Network settings and to specify regional configuration settings to make Quadro operational in its LAN. **The System Configuration Wizard must be run upon Quadro first startup.**

For the basic configuration, some pages in this wizard may be skipped and left default for the basic configuration.

Please Note: It is strongly recommended that factory default settings are left unchanged if their meanings are not completely understandable to the party administrating the Quadro.

System Configuration

The first page of System Configuration Wizard shows all items to be configured. Click the **Next** button to start. Enter into the **Host Name** field the unique name (top right corner, under Epygi logo) for the Quadro device. The **Domain Name** text field requires the LAN side domain name which the Quadro belongs to.

For a basic configuration, the **LAN IP address** does not need to be changed, but if you must change it (for example, to integrate the device into an existing LAN), record the new LAN IP address and have it handy. You'll need it for subsequent access to Quadro's management.



Fig. I-29: System Configuration page

Clicking **Next** shows the page **DHCP Settings for the LAN Interface**.

DHCP Settings for the LAN Interface

If the DHCP server is enabled, the Quadro will automatically assign dynamic IP addresses to the stations connected to its LAN port.

If you didn't change the default LAN IP address of the Quadro, you also may leave the default values for the **IP Address Range**. Make sure your connected LAN devices belong to the same network as the LAN port of your Quadro.

Please Note: Make sure there is only one DHCP server on the LAN, otherwise, unpredictable network behavior can occur.

The screenshot shows the 'System Configuration Wizard' window with the 'Network' tab selected. The 'DHCP Settings for the LAN Interface' section is highlighted with a red border. It includes the following elements:

- A checkbox for 'Enable DHCP Server' which is currently unchecked.
- A 'Dynamic IP Address Range' field showing 'from 172.30.0.100 to 172.30.0.254', with 'IP-Clipboard' buttons on either side.
- A 'WINS Server' field showing '0.0.0.0' with an 'IP-Clipboard' button.
- A 'Static mappings: None' label.
- Navigation buttons at the bottom: 'Previous', 'Next', 'Cancel', and 'Help'.

Copyright (C) 2005-2009 Epygi Technologies, Ltd. All rights reserved.

Fig. I-30: DHCP Settings for the LAN Interface page

Click on **Next** to display the **Regional Settings** page.

Regional Settings

If your Quadro is located outside of the United States, it is important to properly configure your line connections to the PSTN in your location.

The screenshot shows the 'System Configuration Wizard' window with the 'Regional Settings and Preferences' section highlighted by a red border. It includes the following elements:

- 'Your locale (location):' dropdown menu set to 'US'.
- 'Timezone:' dropdown menu set to '(GMT-06:00) Central Time (US & Canada)'.
- 'Choose Default GUI Theme' section with two radio buttons: 'Plan' (unchecked) and 'Dynamo' (checked and highlighted with a red box).
- A checkbox for 'Choose Theme on Login' which is unchecked.
- Navigation buttons at the bottom: 'Previous', 'Next', 'Cancel', and 'Help'.

Copyright (C) 2005-2009 Epygi Technologies, Ltd. All rights reserved.

Fig. I-31: Regional Settings page

Proper configuration of **Regional Settings** is important for the functionality of the voice subsystem. The **Regional Settings** determine the proper telephony parameters on the LINE and PHONE ports of the Quadro for the specified country. Select the country where the Quadro is located. If you do not find your country in the list, pick the closest in your timezone.

The Quadro obtains the correct time automatically over the Internet from a time server. If you are not located in the US/Central standard time zone, you will need to change the **Timezone** to your region.

Click on **Next** to display the **Emergency and PSTN Access Code Settings** page.

Emergency and PSTN Access Code Settings

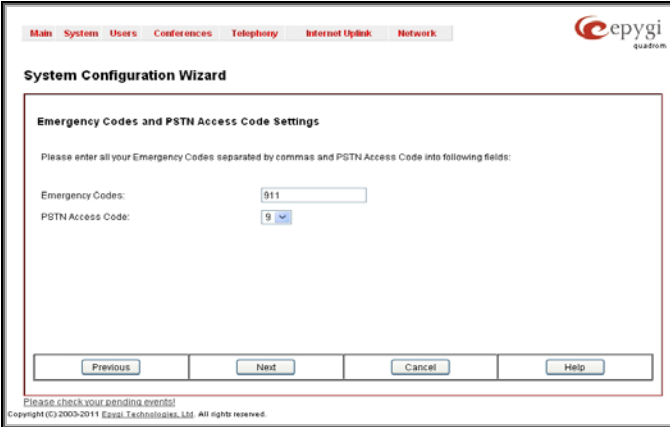

The screenshot shows the 'System Configuration Wizard' interface. At the top, there is a navigation bar with tabs: 'Main', 'System', 'Users', 'Conferences', 'Telephony', 'Internet Upload', and 'Network'. The 'Telephony' tab is selected. The 'epygi' logo is in the top right corner. The main heading is 'System Configuration Wizard'. Below it, the section is titled 'Emergency Codes and PSTN Access Code Settings'. A message reads: 'Please enter all your Emergency Codes separated by commas and PSTN Access Code into following fields:'. There are two input fields: 'Emergency Codes:' with a text box containing '911', and 'PSTN Access Code:' with a dropdown menu showing '9'. At the bottom, there are four buttons: 'Previous', 'Next', 'Cancel', and 'Help'. A small copyright notice is visible at the bottom left: 'Please check your pending credits! Copyright (C) 2003-2011 Epygi Technologies, Ltd. All rights reserved.'

Fig. I-32: Emergency and PSTN Access Code Settings page

You may enter your local specific emergency codes into the appropriate field. For example, in the United States the emergency number is 911, whereas in Germany it is 112, 110. In case of an emergency you can then pick up any FXS phone and dial your configured emergency code without any prefixes for PSTN calls.

The PSTN Access Code is the prefix number you choose to dial to tell the Quadro to “make this call over PSTN”. Users in the United States will usually choose 9 here. European users usually would want to enter zero (0). If you do not enter anything into this field, the PSTN Access Code configuration should be done manually from the Call Routing table.

Click on **Next** to display the **Summary Page**.

Finishing the System Configuration Wizard

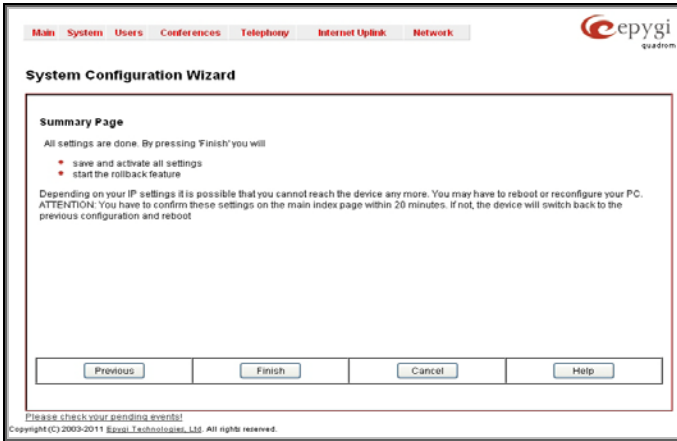

Fig. I-33: System Configuration Wizard finishing page

Click on **Finish** to complete the System Configuration Wizard. The Quadro will then stop internal functions and apply the changes made in the Wizard.



Fig. I-34: Wizard Execution Progress page

After this is complete, the Quadro will reply with the **Confirm Settings** page requesting confirmation of the changes. Press on **OK** to confirm the settings.

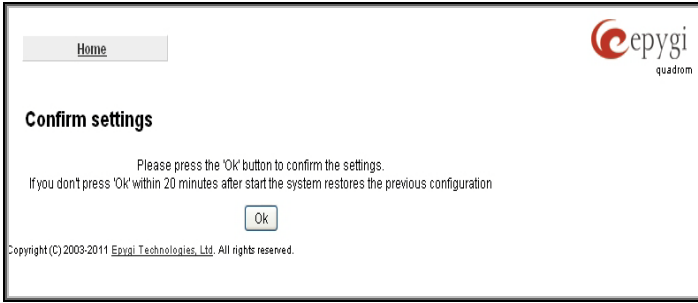

Fig. I-35: Confirm Settings page

Please Note: You must confirm the settings within 20 minutes. Otherwise the device will **revert back to the previous configuration and reboot.**

Please Note: If you do not use DHCP for your LAN and you have changed your LAN settings, make sure that the IP address of the PC connected to Quadro is still within the specified IP address range, otherwise your PC may not establish a connection to Quadro.

If you changed the network configuration of the LAN, restart your LAN connection to receive a new IP address from the new network. Then you can access the Web Management of the Quadro on the new IP address you've assigned to the Quadro.

Step 2.3: Internet Configuration Wizard

Open the **Internet Configuration Wizard** by selecting the corresponding menu item on the **System** menu. The **Internet Configuration Wizard** is a tool for the administrator to configure the WAN settings and to adjust Quadro's connectivity in the global network. It must be run if Quadro is desired to be connected to the Internet.

The page **Getting Started** will be displayed:

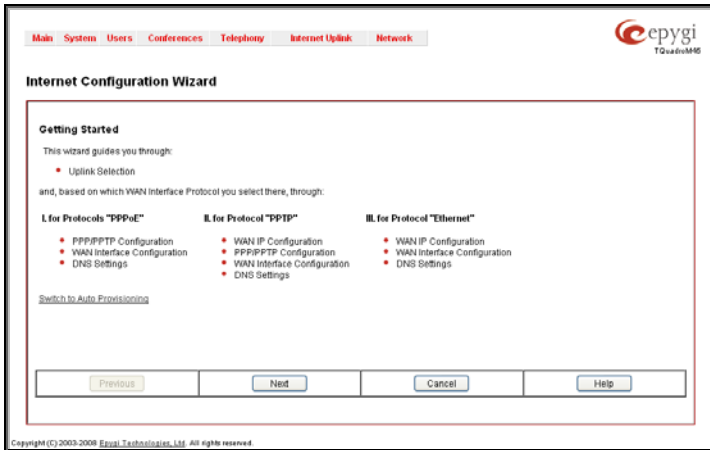

Fig. I-36: Internet Configuration Wizard

This first page of the **Internet Configuration Wizard** is for informational purposes only and lists the items to be configured, Click on the **Next** button for the **Uplink Configuration** page.

Before configuring the WAN port to the Internet, you need to get the following information from your internet service provider:

- **Bandwidth** - how much is available upstream and downstream?
- **WAN IP Configuration** - is DHCP supported? If yes, no more information is needed. If DHCP is not supported, the following data is needed: the WAN IP address, the subnet mask, the IP address of the standard gateway and the IP address of the Domain Name Server (DNS).
- **MAC address** - needed when the ISP requires a specific MAC address for the WAN.

Additionally, for Point-to-Point Protocol over Ethernet (PPPoE) WAN interface, you need to get the following information from your internet service provider:

- **PPP Configuration** - does your ISP use a dynamic or fixed WAN IP address? If the WAN IP address is dynamic, no more information is needed. If the WAN IP address is fixed, you will have to enter it.
- **Authentication** - does your ISP require authentication? If authentication is required, information about the corresponding method (PAP, CHAP or MSCHAP) is needed including the username and password of the PPPoE account.

This information will be needed to be inserted in the Internet Configuration Wizard.

Uplink Configuration

Select the desired WAN Interface Protocol and enter the **WAN Interface Bandwidth** to assure the quality of IP calls.

The screenshot shows the 'Internet Configuration Wizard' window with the 'Uplink Configuration' tab selected. Under 'WAN Interface Protocol', three options are listed: PPPoE, PPTP, and Ethernet. The Ethernet option is selected with a green circle. To the right, under 'WAN Interface Bandwidth', there are three input fields: 'Upstream' with the value '100000' and '(kbit/s) (max: 100000)', 'Downstream' with the value '100000' and '(kbit/s) (max: 100000)', and 'Min Data Rate' with the value '0' and '(kbit/s)'. At the bottom of the wizard, there are four buttons: 'Previous', 'Next', 'Cancel', and 'Help'. A small note at the bottom left says 'Please check your pending events!' and a copyright notice is at the very bottom.

Fig. I-37: Uplink Configuration

If the available bandwidth is used to the point where the quality of an additional IP call would suffer, then new IP calls are rejected.

The bandwidth provided by your ISP must be specified for both **Upstream** and **Downstream** fields. The default entry in both fields is **100000**, the maximum bandwidth of the 100 MB uplink module. For basic DSL and cable modem service in the United States, typical values are **300** for Upstream and **1500** for Downstream.

The **Min Data Rate** text field is used to specify the amount of bandwidth reserved for data applications. The value entered here needs to be smaller than the value specified for **Upstream Bandwidth**.

Specify the **WAN Interface Protocol** by choosing between available WAN interface protocols: **PPPoE** (Point to Point over Ethernet), **PPTP** (Point to Point Tunneling Protocol) and **Ethernet**. Use Ethernet for DHCP or static IP.

For **Ethernet**, clicking **Next** will display the **WAN IP Configuration** page. If **PPPoE** is the selected WAN Interface Protocol, the next page will be **PPP/PPTP Configuration**. For **PPTP** WAN Interface Protocol, **PPP/PPTP Configuration** page will follow the **WAN IP Configuration**.

WAN IP Configuration

Your Internet Service Provider (ISP) should provide this information.

- **Assign automatically via DHCP** - The parameters are set automatically by the ISP. This is common with cable modem and DSL service.
- **Assign Manually** requires the administrator to enter the external **IP Address**, the corresponding **Subnet Mask**, and the IP address of the **Standard Gateway**. This is common when you have a static IP address with your ISP.

The screenshot displays the 'Internet Configuration Wizard' interface. At the top, there is a navigation menu with 'Main', 'System', 'Users', 'Conferences', 'Telephony', 'Internet Uplink', and 'Network'. The 'e pygi' logo is in the top right corner. The main heading is 'Internet Configuration Wizard'. Below it, the 'WAN IP Configuration' section is titled 'IP configuration of the WAN interface'. There are two radio button options: 'Assign automatically via DHCP' (unselected) and 'Assign manually' (selected). The 'Assign manually' option is expanded to show three rows of input fields: 'IP Address' with values 192, 168, 74, 162 and an 'IP-Clipboard' button; 'Subnet Mask' with values 255, 255, 255, 0 and an 'IP-Clipboard' button; and 'Default Gateway' with values 192, 168, 74, 5 and an 'IP-Clipboard' button. At the bottom of the form area are four buttons: 'Previous', 'Next', 'Cancel', and 'Help'. A small warning message at the bottom left reads 'Please check your pending events!'. The footer contains the text 'Copyright (C) 2009-2011 Epygi Technologies, Ltd. All rights reserved.'

Fig. I-38: WAN IP Configuration page

Click on **Next** to display the **WAN Interface Configuration** page.

PPP/PPTP Configuration

Enter the IP address of the PPTP server into the **PPTP Server** text field.

Choose the encryption for the traffic over the PPTP interface from the **Encryption** drop down list.

Authentication Settings require the Username and the Password used for the authentication on the ISP server.

Dial Behavior radio buttons:

- **Dial Manually** - if this radio button is activated, a button will be displayed in the main management window that serves to switch the Internet connection on/off. When accessing the Internet, every station of the connected LAN has to connect to Quadro first.
- **Always connected** - Quadro stays in the always connected mode. This will allow Quadro always remain online in the network.

The **IP Address Assignment** field is used to specify the external IP address given to the Quadro. Usually it is a dynamic address but in some cases you may be given a static IP address.

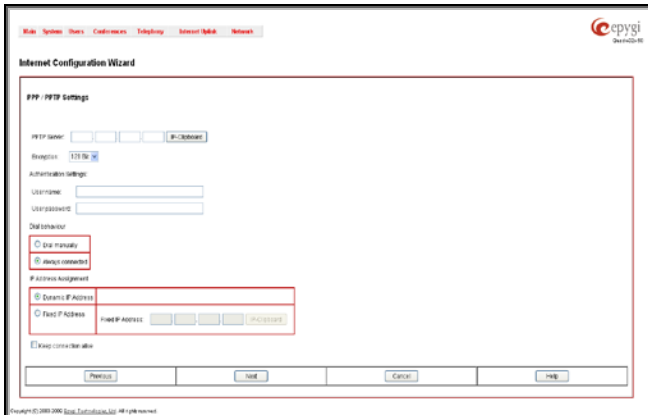

Fig. I-39: PPP/PPTP Configuration page

If your ISP assigns a dynamic IP address, activate the **Dynamic IP Address** radio button, otherwise activate the **Fixed IP Address** radio button and enter the IP address you were assigned by your ISP.

Keep Connection alive checkbox enables keeping the connection alive by sending control packets dedicated for the link state verification.

Click the **Next** button to display the **WAN Interface Configuration** page.

WAN Interface Configuration

If your ISP requires a specific MAC address, (for example, for authentication), it can be entered on this page. The required MAC address can be entered into the **User defined** field. If a specific MAC address is not required, leave the default selection **This device** selected.

The screenshot shows the 'WAN Interface Configuration' section of the 'Internet Configuration Wizard'. At the top, there are navigation tabs: Main, System, Users, Conferences, Telephony, Internet Upload, and Network. The 'Internet Upload' tab is active. The wizard title is 'Internet Configuration Wizard'. Below the title, the section is 'WAN Interface Configuration'. Under 'MAC Address Assignment', there are two radio buttons: 'This device' (selected) and 'User defined'. The 'This device' option shows the MAC address '00:09:a0:00:12:39'. The 'User defined' option has five empty input fields. Below this, the 'Maximum Transfer Unit (MTU)' is set to '1500' in a dropdown menu, followed by 'Bytes'. At the bottom, there are four buttons: 'Previous', 'Next', 'Cancel', and 'Help'. A small note at the bottom left says 'Please check your pending events!' and 'Copyright (C) 2009-2011 Epygi Technologies, Ltd. All rights reserved.'

Fig. I-40: WAN Interface Configuration page

Use the **MTU** drop down list to select the maximum packet size on the Ethernet (in bytes). Click **Next** to display the **DNS Settings** page.

DNS Settings

For DNS, the selection is set to **Dynamically by Provider**. When using a static IP address, fixed values must be entered.

The screenshot shows the 'DNS Settings' section of the 'Internet Configuration Wizard'. At the top, there are navigation tabs: Main, System, Users, Conferences, Telephony, Internet Upload, and Network. The 'Internet Upload' tab is active. The wizard title is 'Internet Configuration Wizard'. Below the title, the section is 'DNS Settings'. Under 'Nameserver assignment', there are two radio buttons: 'Dynamically by provider' and 'Fixed Nameserver Address' (selected). The 'Fixed Nameserver Address' option has two rows of input fields: 'Nameserver' with values '192', '168', '0', '2' and an 'IP-Clipboard' button; and 'Alternative Nameserver' with values '192', '168', '0', '156' and an 'IP-Clipboard' button. At the bottom, there are four buttons: 'Previous', 'Next', 'Cancel', and 'Help'. A small note at the bottom left says 'Please check your pending events!' and 'Copyright (C) 2009-2011 Epygi Technologies, Ltd. All rights reserved.'

Fig. I-41: DNS Settings page

The Quadro will suggest the correct settings. If **Dynamically by Provider** is selected, the DNS server settings will be set automatically whenever a connection to the Internet is established.

If **Fixed Nameserver Address** is selected, manually enter the IP addresses provided by your ISP for the name server and the alternative name server.

Clicking **Next** shows the summary page of the Internet Configuration Wizard.

Finishing the Internet Configuration Wizard



Fig. I-42: Internet Configuration Wizard Summary page

Click the **Finish** button to complete the Internet Configuration Wizard. The Quadro will then stop internal functions and apply the changes made in the Wizard. After this is complete, the Quadro will display the **Confirm Settings** page requesting confirmation of the changes. Press the **OK** button to confirm the settings.

Please Note: The settings should be confirmed within 20 minutes; otherwise, the device will **revert back to the previous configuration and reboot**.

Step 2-A: Using IP Lines

Before starting the IP Lines specific configuration, the appropriate IP Phone (the list of SIP phones supported by Quadro is presented below) should be connected to the Quadro either through its LAN or WAN port. If the phones are placed on the Quadro WAN, please ensure that the **Connect IP phones from WAN side** checkbox is enabled on the **Line Settings** page (see Fig. I-43).

Each IP line should be configured individually from the **Telephony** menu, **Line Settings** page, **IP Line Settings** tab.

The screenshot shows the 'Line Settings' page in the Quadro web interface. The page has a navigation bar at the top with tabs: Main, System, Users, Conferences, Telephony, Internet/Link, and Network. The 'Telephony' tab is selected. The page title is 'Line Settings'. There are several checkboxes and a dropdown menu for configuring IP lines. Below these is a table of available IP lines.

Available IP Lines	Attached Extension	Type	Details
IP Line 1	103	SIP	UseName: locet103, Model: Grandstream GSP1430, 00:00:82:3e:9f:5b, Template: systemdefault
IP Line 2	104	SIP	UseName: locet104, Model: Grandstream GSP120, 00:00:82:29:3e:42, Template: systemdefault, Advanced View Refresh
IP Line 3	105	SIP	UseName: locet105, Model: Sionix 720, 00:04:13:70:00:BF, Template: systemdefault, Advanced
IP Line 4	106	SIP	UseName: locet106, Model: Epygi QuadroFXS 16, 00:00:00:00:00:02, Template: systemdefault, Advanced
IP Line 5	107	SIP	UseName: locet107, Model: Epygi QuadroFXS 16, 00:00:00:00:00:02, Template: systemdefault, Advanced
IP Line 6	108	SIP	UseName: locet108, Model: Epygi QuadroFXD 16, 00:00:00:00:00:02, Template: systemdefault, Advanced
IP Line 7	109	SIP	UseName: locet109, Model: Epygi QuadroFXS 16, 00:00:00:00:00:02, Template: systemdefault, Advanced
IP Line 8	110	SIP	UseName: locet110, Model: Epygi QuadroFXS 16, 00:00:00:00:00:02, Template: systemdefault, Advanced
IP Line 9	111	SIP	UseName: locet111, Model: Epygi QuadroFXS 16, 00:00:00:00:00:02, Template: systemdefault, Advanced
IP Line 10	112	SIP	UseName: locet112, Model: Epygi QuadroFXD 16, 00:00:00:00:00:02, Template: systemdefault, Advanced
IP Line 11	113	SIP	UseName: locet113, Model: Epygi QuadroFXS 16, 00:00:00:00:00:02, Template: systemdefault, Advanced

At the bottom of the table, there are 'Save' and 'Back' buttons. Below the table, there is a small text: 'Please check your device events! Copyright (C) 2009-2013 Epygi, Inc. All rights reserved.'

Fig. I-43: Line Settings page

Click on the IP Line number to enter the **IP Lines Settings** page.

The screenshot shows the 'IP Line Settings - IP Line 1' configuration page. At the top, there are navigation tabs: Main, System, Users, Conferences, Telephony, Internet Uplink, and Network. The 'epygi' logo and 'QuadroM32x/8L' are in the top right. The main content area has a left sidebar with radio buttons for 'Inactive' and 'SIP Phone' (selected). The 'SIP Phone' section contains the following fields:

- Phone Model: Snom 300 (dropdown)
- MAC Address: 00 | 04 | 13 | 25 | 29 | 10 (text boxes)
- Line Appearance: 2 (text box)
- Username: flocext103 (text box)
- Password: [masked] (text box) with a 'Choose Generated Password' button
- Transport: UDP (dropdown)
- Use Session Timer
- Use template: <- use default -> (dropdown)
- Enable Hot Desking Capability
- Hot Desking Automatic Logout:
 - Never
 - After 0 hour(s) 0 min
 - At 0 : 0

At the bottom, there are 'Save', 'Back', and 'Help' buttons. A footer note says 'Please check your pending events!' and 'Copyright (C) 2003-2011 Epygi Technologies, Ltd. All rights reserved.'

Fig. I-44: IP Line Settings page

Select the **SIP Phone** radio button. Select the SIP IP phone model from the **Phone Model** drop down list. Insert the SIP Phone's **MAC address** in the corresponding fields. The MAC address of an IP phone is usually printed on the back of the phone's base unit.

In the **Line Appearances** text box, enter the number for simultaneous calls supported by the SIP IP phone – which is the sum of the number of active and held calls. For example, if this field is set to **1**, only one active call is possible to have on the phone and making or accepting a second call while the other is on hold will not be allowed. Note, that this number depends on the phone brand and model, and cannot exceed the number of simultaneous calls supported by the phone.

To simplify the configuration procedure, Quadro generates unique identification parameters (see **Username** and **Password**). You may use either these values or specify new ones. The **Password** field is checked against its strength and you may see how strong is your inserted password right below that field. A well protected, strong password has a minimum of 8 characters of letters in upper and lower case, symbols and numbers. If you are unable to define a strong password, press **Choose Generated Password** to use one of the system defined strong passwords.

The **Transport** drop down list is used to select the SIP protocol transport layer - UDP, TCP or TLS. For TLS you may activate the TLS certificate update mechanism from IP Phone to obtain the latest certificate generated by the Quadro.

The **Use Session Timer** enables the SIP session timer for the corresponding IP line. This checkbox enables advanced mechanisms for connection activity checking. This option allows both user agents and proxies to determine if the SIP session is still active.

The **Enable Hot Desking Capability** checkbox is used to enable the Hot Desking feature on the corresponding IP line (for details, see Manual II – Administrator's Guide).

The **Hot Desking Automatic Logout** section is used to configure Hot Desking functionality expiration on the corresponding IP line. This may be useful when someone who logged in to the public phone with the extension attached to this line forgot to log out after using it. With this option enabled, once the expiration time arrives, the extension will automatically log out from the public phone.

The following options are available:

- **Never** – the extension will never expire and will remain logged in to the public phone.
- **After the defined period of time** – requires the period after which the extension will automatically log out from the public phone.
- **At the certain moment** – requires the moment (hour and minute) when the extension will automatically log out from the public phone.

Press **Save** to apply the settings for the IP line.

Reset the SIP Phone. After restart, the appropriate configuration will be automatically downloaded from the Quadro to the SIP Phone.

Please Note: For automatic configuration, some SIP phones may require additional actions to follow the restart. For example, by default the IP Dialog SIP Tone II is in a non-auto-provisioning mode, so it should be manually enabled on the phone. Refer to the user's manual of the corresponding SIP phone for instructions on performing a factory reset or reboot on any of the supported phones, what additional configurations are required for a specific SIP phone, and how to manipulate with the GUI.

You may also find the detailed installation instructions of the Epygi's supported IP Phones in the "**Configuring Epygi Supported IP Phones**" document published on Epygi's Web portal.

To make sure the line configuration works properly, do the following:

- Go to **System – Status - IP Line Registration Status** to see if IP Line registration is successful.
- Dial *74 to get the line information.
- Make outgoing and accept incoming calls.

Supported SIP Phones

Below is the list of SIP phones that are officially supported by Epygi and can be configured to work with QuadroM using both Plug and Play and the automatically configuration options, as well as the full set of advanced features, like paging and intercom:

- snom 190
- snom 200
- snom 220
- snom 300
- snom 320
- snom 360
- snom 370
- snom 710
- snom 720
- snom 760
- snom 820
- snom 821
- snom 870
- snom M3
- snom PA1
- snom m9
- snom MeetingPoint
- IpDialog SipTone II
- Polycom SoundPoint IP 300SIP
- Polycom SoundPoint IP 330SIP*
- Polycom SoundPoint IP 331SIP*
- Polycom SoundPoint IP 335SIP*
- Polycom SoundPoint IP 450SIP*
- Polycom SoundPoint IP 501SIP
- Polycom SoundPoint IP 550SIP*
- Polycom SoundPoint IP 601SIP
- Polycom SoundPoint IP 650SIP*
- Polycom SoundStation IP 5000*
- Polycom SoundStation IP 6000*
- POLYCOM VVX 1500*
- Polycom VVX 300/310*
- Polycom VVX 400/410*
- POLYCOM KIRK wireless server 6000
- POLYCOM KIRK wireless server 300
- Aastra 9133i
- Aastra 480i
- Aastra 480iCT
- Aastra 9143i(33i)
- Aastra 9480i(35i)
- Aastra 9480iCT
- Aastra 6751i
- Aastra 6753i
- Aastra 6755i
- Aastra 6757i(57i)
- Aastra 6757iCT (57iCT)
- Aastra 6730i
- Aastra 6731i
- Aastra 6735i
- Aastra 6737i
- Aastra 6739i
- Linksys SPA921
- Linksys SPA922
- Linksys SPA941
- Linksys SPA942
- Linksys SPA2002
- Linksys PAP2T
- Fanvil C62
- Akuvox SP-R53P
- Yealink SIP-T20P
- Yealink SIP-T22P
- Yealink SIP-T26P
- Yealink SIP-T28P
- Yealink SIP-T32G
- Yealink SIP-T38G
- Yealink SIP-T46G
- Yealink W52P
- Yealink VP-2009/VP-2009P
- Yealink VP530

- SIPUra SPA 841
- Swissvoice IP 10S
- Thomson ST2030S
- Grandstream BT100
- Grandstream BT200
- Grandstream GXP1400
- Grandstream GXP1405
- Grandstream GXP1450
- Grandstream GXP2000
- Grandstream GXP2100
- Grandstream GXP2110
- Grandstream GXP2120
- Grandstream GXP2124
- Grandstream GXP2200
- Grandstream GXV3140
- Grandstream GXV3175
- Grandstream HT286
- Grandstream HT386
- Aastra 9112i
- Yealink W52P
- Aastra MBU400
- Telematrix IP550 Spectrum Plus
- Telematrix IP 3300
- Telematrix IP9600 MWD5
- AudioCodes 310HD
- AudioCodes 320HD
- Panasonic KX-UT136
- Panasonic KX-UT123
- Panasonic KX-TGP550T04
- Alcatel Temporis IP200
- Alcatel Temporis IP600
- Alcatel Temporis IP800
- CISCO 7960
- CISCO SPA525G2
- CISCO SPA303
- CISCO SPA501G
- CISCO SPA509G
- Berkshire (ATL) 5000

To use Plug and Play (PnP) option for IP phones, connect them to LAN/WAN for the Quadro and power up. If the phone is in default settings then it will automatically select a free IP line and attach to an extension. If not, reset the phone to factory defaults manually.

Please Note: To use PnP the appropriate option should be selected in the IP line settings.

Please Note: In the model's list the Polycom phones with (*) sign are also presented as **Polycom-xx-Pre-3.3.0** due to backward incompatibility of UCSoftware 3.1.1 configuration. It is recommended to use **Pre-3.3.0** models with Application SIP software 3.2.2.0477.

Step 2-B: Using Receptionist

If you wish to use the Receptionist's features, the Receptionist should be set up on the Quadro. The Quadro's basic configuration should be done in the same way as described in the Step 2.

The Receptionist related setup, with detailed instructions on how to configure the Quadro and the attached IP Phones, is described in the "**Receptionist Setup on Quadro**" document, which you can find at the Epygi's Web portal.

Step 2-C: Using ISDN Lines

The basic configuration procedure for QuadroM IP PBXs that use ISDN lines is exactly the same as described in Step 2.

As some ISDN providers require an outgoing MSN to be defined, go to the **Telephony** menu and open the **ISDN Settings** page.

The number of available ISDN trunks is dependent on the type of your Quadro. QuadroM26xi and QuadroM12Li have six ISDN trunks.

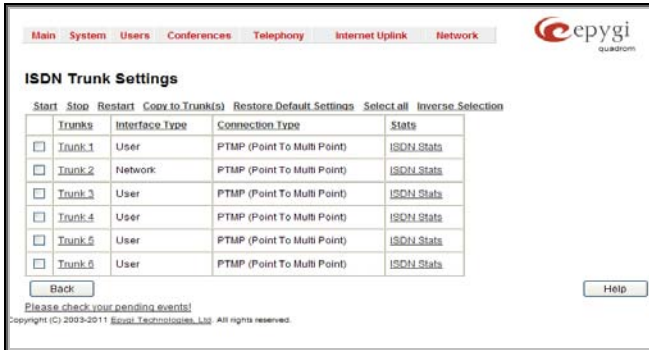

Fig. I-45: ISDN Trunk Settings page

Before starting the ISDN Trunk configuration, please consult with your ISDN provider administrator to receive instructions for which settings are necessary to be configured.

Run the **ISDN Wizard** for each ISDN trunk to make sure that all settings are proper. To access **ISDN Wizard**, push the appropriate trunk number in the ISDN Trunk Settings table.

The **ISDN Wizard – ISDN Settings** allows you to choose the interface type and the connection type of the selected trunk(s).

The **Interface Type** drop down list allows you to select between the User and the Network interfaces. If the ISDN port of the Quadro is connected to the CO then **User** interface type should be selected. If the ISDN port of the Quadro is connected to the PBX then **Network** interface type should be selected (in that case Quadro acts as a CO for that PBX).

The **Connection Type** manipulation radio button group allows you to choose the connection type for the selected trunk(s):

- **PTP (Point to Point)**

In case of connection to the CO (**User** interface type is selected on Quadro) choose this option if only Quadro is connected to the ISDN trunk from CO (no other ISDN devices are connected to the particular ISDN trunk from CO besides the Quadro).

In case of connection to the PBX (**Network** interface type is selected on Quadro) choose this option if only the PBX is connected to the ISDN trunk from the Quadro (no other ISDN devices are connected to the particular ISDN trunk from the Quadro).

In both cases, with this selection, Quadro sets the TEI to manually mode assigning the default value of 0. If needed, that value can be changed later in the **Advanced Settings** page of ISDN Wizard.

- **PTMP (Point to Multi Point)**

In case of connection to the CO (**User** interface type is selected on the Quadro) choose this option if there can be other devices connected to the same ISDN trunk from CO except the Quadro.

In case of connection to PBX (**Network** interface type is selected on the Quadro) choose this option if there can be other devices connected to the same ISDN trunk from Quadro except for the PBX.

In both cases, with this selection Quadro sets the TEI to automatic mode.

Please Note: Consult with your CO operator or network administrator before configuring the ISDN connection type.

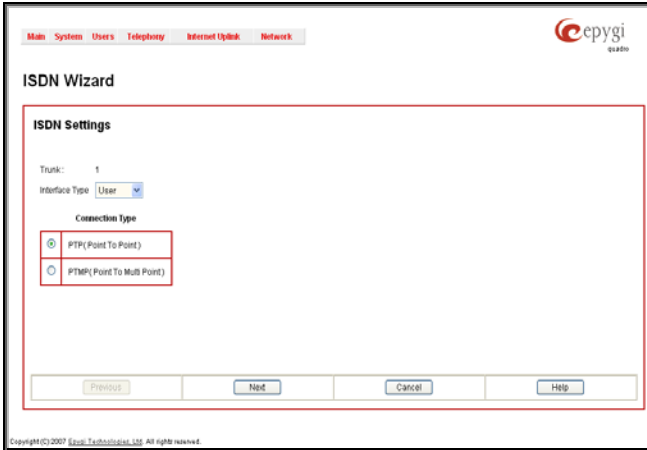

Fig. I-46: ISDN Wizard – ISDN Settings

The **ISDN Wizard - Page 2** content is dependent on the connection type selected on the previous page of **ISDN Wizard**:

The next page is **ISDN Wizard – MSN Settings** page which is used to turn on the MSN configuration. It is recommended to enable the MSN when there are multiple ISDN devices connected to the same ISDN bus. If the MSN is enabled on this page, the next page will require the MSN table configuration.

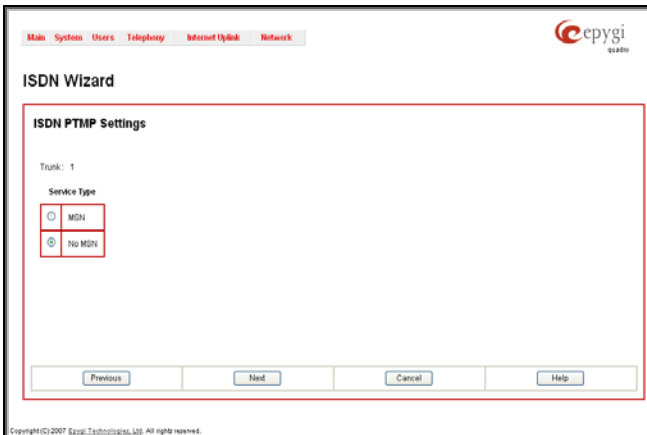

Fig. I-47: ISDN Wizard – ISDN PRMP Settings

For MSN service enabled, the **Routing Settings** page is used to assign MSN numbers to

the certain destinations on the Quadro. The MSN number can be assigned to the Quadro's extensions, to the Auto Attendant, or to the routing agent. The destination selected from this page will ring upon incoming call to the corresponding MSN number comes in.

The fields in the **MSN Number** column require the MSN numbers allocated to the Quadro.

Please Note: At least one MSN number should be defined in this page. The system displays an error message if the same MSN number is used twice in this page.

The **Route Incoming Call to** drop-down lists is used to select the destination where the incoming call addressed to the certain MSN number will be routed. Choosing the **Routing with inbound destination number** selection will automatically use the initially dialed number to connect the destination without any additional dialing. If MSN is disabled on the **ISDN Wizard - MSN Settings** page, the **ISDN Wizard - Routing Settings** page contains only one **Route Incoming Call to** drop-down list.

Selecting the **Use Default outgoing Caller ID** allows you to overwrite the source caller information with the one specified in the **Default outgoing Caller ID** field when placing outgoing calls toward the CO. The **Default outgoing Caller ID** field requires the caller ID for the outgoing calls from the Quadro through the ISDN trunk. That number should be registered at the CO and can be one of the MSNs provided by the CO. If this checkbox is enabled but no value is defined in the **Default outgoing Caller ID**, empty caller information will be sent to the CO. If this checkbox is disabled, the source caller information will be forwarded to the CO.

Select the **Advanced Settings** checkbox if you wish to adjust trunk L2 and L3 Settings manually, otherwise leave this checkbox unselected to use the system default values.

The screenshot displays the 'ISDN Wizard - Routing Settings' configuration page. At the top, there are navigation tabs: Main, System, Users, Telephony, Internet/Trunk, and Network. The 'Telephony' tab is active. The page title is 'ISDN Wizard' and the sub-section is 'Routing Settings'. Below this, it indicates 'Trunk: 1'. A table lists MSN numbers from 521001 to 521010, each with a corresponding 'Route Incoming Call to' dropdown menu. The dropdown for MSN 521004 is expanded, showing 'Routing with inbound destination number' as the selected option. Below the table, there are two checkboxes: 'Use Default outgoing Caller ID' (checked) and 'Advanced Settings' (checked). The 'Default outgoing Caller ID' field contains the value '10297098'. At the bottom, there are four buttons: Previous, Next, Cancel, and Help. A copyright notice for Epygi Technologies, LLC is visible at the very bottom of the window.

MSN Number(s)	Route Incoming Call to
521001	00
521002	11
521003	12
521004	Routing with inbound destination number
521005	14
521006	15
521007	31
521008	32
521009	33
521010	37

Use Default outgoing Caller ID
 Default outgoing Caller ID: 10297098

Advanced Settings

Fig. I-48: ISDN Wizard – Routing Settings

The **ISDN Wizard – L2&L3 Settings** is used for advanced configuration only and contains L2&L3 Settings. This page only appears when the **Advanced Settings** checkbox is selected on the previous page of the wizard. This page contains the following components:

The screenshot shows the 'ISDN Wizard' window with the 'L2 & L3 Settings' tab selected. The window contains several configuration sections:

- Timers:** Fields for Excessive Ack. Delay T200 (300), Idle Timer T203 (3200), T302 Timer (9000), T309 Timer (0), T310 Timer (90000), and Alert Guard Timeout (150).
- Coding Type:** Set to 's-law'.
- Passive Mode:** Enable TEI Remove Procedure, Permanent TEI Value.
- Switch Type:** Set to 'basic_dss1'.
- Channel Selection:** Set to 'preferred'.
- Bearer Establishment Procedure:** Set to 'on progress indication with in-band information'.
- Called Party Type of Number:** Set to 'Unknown'.
- Calling Party Type of Number:** Set to 'Unknown'.
- Called Party Numbering Plan:** Set to 'ISDN:telephony numbering plan'.
- Calling Party Numbering Plan:** Set to 'ISDN:telephony numbering plan'.
- Generate Progress Tone to PSTN/PBX:** Set to 'None'.
- Incoming Called Digits Size:** Set to '8'.
- Generate Progress Tone to IP:**
- Enable CLR Service:**
- Alternative Disconnection Mode:**
- P-Asserted-Identity (highlighted):**
 - Disable P-Asserted-Identity
 - Override CLID with P-Asserted-Identity
 - Use Redirecting Number Info Element with P-Asserted-Identity
- Other options:** Send Calling Party SubAddress, Ignore Empty Channel Identification in CALL PROCEEDING Msg, B1 Channel, B2 Channel.

Navigation buttons at the bottom include 'Previous', 'Next', 'Cancel', and 'Help'. A copyright notice is visible at the bottom left: 'Copyright © 2004-2011 Epygi Technologies, LLC. All rights reserved.'

Fig. I-49: ISDN Wizard – L2&L3 Settings

ISDN L2 Timers:

- **Excessive Ack. Delay T200** configures the period in milliseconds (numeric values from 500 to 9999) between the transmitted signaling packet and its acknowledgement received.
- **Idle Timer T203** configures the period in milliseconds (numeric values from 1000 to 99999) for the ISDN client idle timeout.

ISDN L3 Timers:

- The **T302 Timer** text field requires the value for the T302 timer in milliseconds (digit values from 0 to 15000). It indicates that the time frame system is waiting for a digit to be dialed. When the timer expires, it initiates the call.
- **T309 Timer** requires the value for the T309 timer in milliseconds (numeric values from 0 to 90000). It is responsible for call steadiness during link disconnection within the period equal to this timer value. If the value in this field is zero (0), the T309 timer will be disabled.
- **T310 Timer** requires the value for the T310 timer in milliseconds (numeric values from 1000 to 120000). It is responsible for the outgoing call steadiness when CALL PROCEEDING is already received from the destination but call confirmation (ALERT, CONNECT, DISC or PROGRESS) has not yet arrived.
- **Alert Guard Timeout** requires the value for the Alert Guard Timer in milliseconds (numeric values from 0 to 500) between CALL PROC and ALERT messages. **Alert Guard Timer** it is used when Quadro is connected to a slow ISDN-PBX. Recommended values are:
 - fast connection (0ms);
 - normal (150ms), default;
 - slow ISDN-PBX (350ms);

- very slow ISDN-PBX (500ms).

The **Coding Type** drop down list allows you to select between **a-law** and **mu-law** coding types.

The **Switch Type** is another configuration parameter that depends on the Service Provider. The **Passive Mode** checkbox is used to leave the ISDN Layer1 connection in the Slave mode. When this checkbox is selected, Layer1 remains idle when calls are not available. When this checkbox is not selected, Quadro keeps its Layer1 always active. This checkbox enables the **Enable TEI Remove Procedure** and **Permanent TEI Value** checkboxes. With the **Enable TEI Remove Procedure** checkbox is selected, the trunk will lose the assigned TEI when entering into passive mode on the Layer 2. With the **Permanent TEI Value** checkbox is selected, the trunk will keep the assigned TEI when entering into passive mode on the Layer 2 or when Quadro detected ISDN link DOWN signal from carrier.

Channel Selection is used to select between the **Preferred** and **Exclusive B** channel selection methods. For **Preferred** channel selection, the CO answers to the call request by the first available timeslot. With the **Exclusive** channel selection, the CO should feedback only by the timeslot asked in the call request.

The **Bearer Establishment Procedure** drop down list allows selecting the session initiation method on the B channel. One of the following options can be selected for the transmission path completion prior to receipt of a call acceptance indication:

- on channel negotiation at the destination interface
- on progress indication with in-band information
- on call acceptance

The **Calling Party Type of Number** drop down list allows you to select the type identifying the origin of call.

The **Called Party Type of Number** drop down list allows you to select the type identifying the subaddress of the called party of the call.

The **Called Party Numbering Plan** and **Calling Party Numbering Plan** drop down lists correspondingly indicate the numbering plan of the called party's and calling party's number.

The **Incoming Called Digits Size** text field indicates the number of received digits (in a range from 0 to 255) required to establish a call. When this field has a "0" value, the system uses either the timeout defined in the T302 field or the **Sending Complete Information element** messages to establish a call. Independent on the value in this field, **Sending Complete Information element** and the pound sign always result in call establishment.

When **Generate Progress Tone to PSTN/PBX** checkbox is selected, Quadro generates ring tones to callers during ISDN call dialing. This feature is mainly applicable to 2-stage dialing mode.

The **Generate Progress tone on IP** checkbox selection will generate the progress tone to IP.

Enable CLIR Service checkbox selection enables Calling Line Identification Restriction (CLIR) service which displays the incoming caller ID only if Presentation Indication is allowed on the remote side. Otherwise, if CLIR service is disabled, caller ID will be unconditionally displayed.

When the **Alternative Disconnection Mode** checkbox is not selected, Quadro will disconnect the call as soon as the disconnect message has been received from the peer. When the checkbox is selected, Quadro's user may hear a busy tone when peer has been disconnected.

P-Asserted-Identity:

The **Disable P-Asserted-Identity** radio button disables the P-Asserted-Identity feature for both incoming and outgoing calls.

The **Override CLID with P-Asserted-Identity** radio button selection enables SIP P-Asserted-Identity support. For the calls from SIP to ISDN if Invite SIP message contains a P-Asserted-Identity, then the CallerID on ISDN is sent with the original Caller ID, which comes from the identity field. SIP user agent should check for the existence of the P-Asserted-Identity, then the P-Preferred-Identity, then the Remote-Party-ID to fill the identity field.

For the calls from ISDN to SIP with restricted Caller ID, the SIP Invite message contains P-Asserted-Identity field with the value from the Caller ID on ISDN. The SIP From field contains "anonymous".

The **Use Redirecting Number Info Element with P-Asserted-Identity** radio button selection enables full support of the SIP P-Asserted-Identity. For the calls from SIP to ISDN, if the SIP Invite message contains a P-Asserted-Identity or a P-Preferred-Identity or a Remote-Party-ID, then the CallerID on ISDN contains the number from the user name field and the Redirecting Number IE contains the original number from the identity field. SIP user agent should check for the existence of the P-Asserted-Identity, then the P-Preferred-Identity, then the Remote-Party-ID to fill the identity field. For the calls from ISDN to SIP with Caller ID, the SIP Invite message contains P-Asserted-Identity field with the original number value from the Redirecting Number IE on ISDN. The SIP From field contains the value from the user name.

When the **Send Calling Party Subaddress** checkbox is selected, Quadro will send the extension number as subaddress and the value defined in the **Default outgoing Caller ID** field as caller ID on the outgoing call. When this checkbox is disabled, no subaddress information will be sent and the caller ID will be defined according to the selection of the **Use Default Outgoing Caller ID** checkbox (see above). Caller ID information, along with the Subaddress, can be displayed on the phone display depending on the phone and PBX settings and capabilities.

When the **Ignore Empty Channel Identification in CALL PROCEEDING Msg.** option is selected, Quadro will ignore the empty ISDN L3 Channel Identification information element in CALL PROCEEDING message and will not response with STATUS message. When this checkbox is disabled, Quadro will response with STATUS message on empty Channel Identification information element.

The **B1 Channel** and **B2 Channel** checkboxes enables/disables timeslots for voice transfer. Disabling the timeslot will prevent both incoming and outgoing calls.

Step 2-D: Configuring the E1/T1 Settings

The QuadroM32x has one E1/T1 trunk available.

The QuadroM32x can be connected to a PBX or to the PSTN via E1/T1 lines, using E1/T1 CAS/CCS signaling. The QuadroM32x may be connected to act as a **User** (default mode) if connected to directly to the PSTN or as a **Network** if connected to a PBX.

Further, you are required to enter the E1/T1 settings your PSTN provider requires regarding framing, clocking, signaling used and so on. All these settings must be entered on the management page **Trunk Settings** that is displayed when you select **E1/T1 Settings** from the **Telephony** menu:

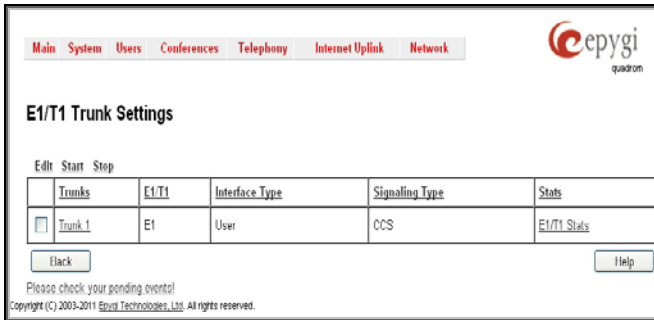

Fig. I-50: E1/T1 Trunk Settings page

The **Trunk Settings** page is used to configure the E1/T1 trunk and timeslots settings. The table lists the available E1/T1 trunks of Quadro and their settings (Trunk name, E1/T1 mode, interface and signaling type). Clicking on the trunk will open its **Signaling Settings** page (Trunk CAS Signaling Settings or the Trunk CCS Signaling Settings page depending on the selected signaling type). Selecting the corresponding trunk's checkbox and pressing **Edit** will open the **Trunk - Edit Entry** page. The **E1/T1 Stats** link is displayed for every active Quadro trunk and leads to the page where the E1/T1 trunk and the traffic statistics can be viewed.

Editing the E1/T1 Trunk

The screenshot shows the 'Trunk - 1 Edit Entry' configuration page. At the top, there are navigation tabs: Main, System, Users, Conferences, Telephony, Internet Uplink, and Network. The 'Network' tab is active. The page title is 'Trunk - 1 Edit Entry'. Below the title, there are dropdown menus for 'Interface Type' (set to 'User') and 'Signaling Type' (set to 'CCS'). The main configuration area is divided into two sections: 'E1' and 'T1'. The 'E1' section is selected and highlighted with a red box. The 'E1' settings are: Line Code (HDB3), Frame Mode (NO_CRC), Line Build Out (120-ohm), Coding Type (a-law), LoopBackMode (No_loopback), and Clock Mode (Slave). The 'T1' section is also visible below the 'E1' section. The 'T1' settings are: Line Code (BRZS), Frame Mode (ESF), Line Build Out (short_110-ft), Coding Type (u-law), LoopBackMode (No_loopback), and Clock Mode (Slave). At the bottom of the page, there are buttons for 'Save', 'Back', and 'Help'. A small text at the bottom left reads: 'Please check your pending events! Copyright (C) 2003-2011 Epygi Technologies Ltd. All rights reserved.'

Fig. I-51: Trunk Edit page

Select **Network** as your **Interface Type** if your QuadroM32x is connected to a PBX, otherwise choose **User**.

Next, you are required to enter the **Signaling type (CAS or CCS)**, adjust the correct interface type (**E1** or **T1**), and specify the requested settings of the selected interface type. The appropriate parameters should be requested from the service provider or in case of connecting to a PBX - according to the settings in the PBX manual.

CAS signaling allows using the same timeslot both for voice and data transmission. CCS signaling uses a single timeslot for signaling data transmission for the whole trunk, all other timeslots are used for voice transmission.

E1, the European system, enables 30 active timeslots (both for CAS and CCS) to be used; T1, the US system, enables 24 timeslots (if CAS is used) and 23 (if CCS is used).

Please Note: Modifying the E1/T1 trunk settings may lead to some broken routes in the Local Call Routing Table.

Signaling Type CCS

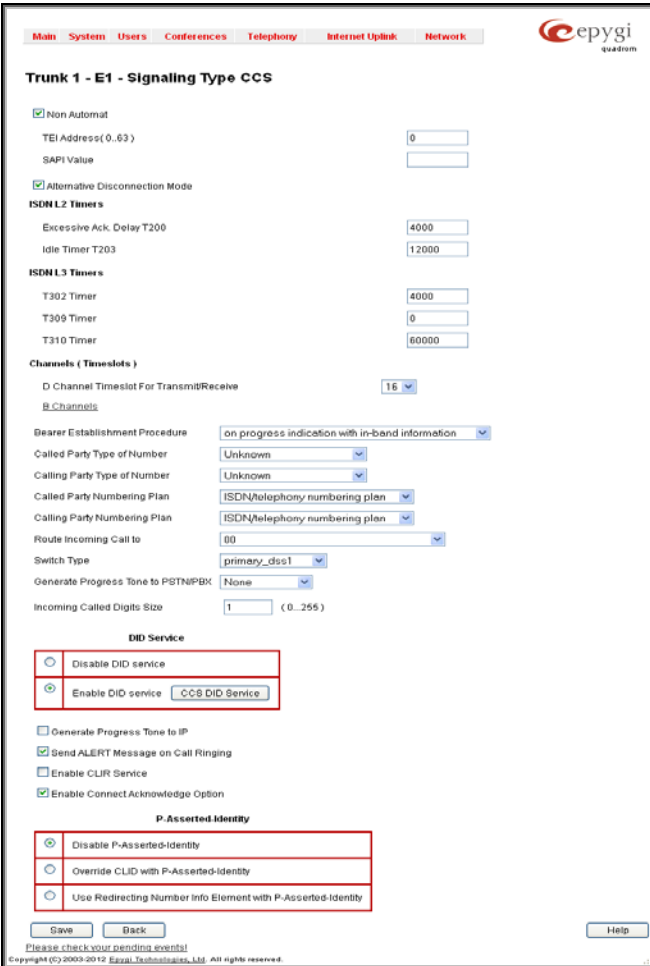

Trunk 1 - E1 - Signaling Type CCS

Non Automat

TEI Address (0..63)

SAPI Value

Alternative Disconnection Mode

ISDN L2 Timers

Excessive Ack. Delay T200

Idle Timer T203

ISDN L3 Timers

T302 Timer

T309 Timer

T310 Timer

Channels (Timeslots)

D Channel Timeslot For Transmit/Receive

[B Channels](#)

Bearer Establishment Procedure

Called Party Type of Number

Calling Party Type of Number

Called Party Numbering Plan

Calling Party Numbering Plan

Route Incoming Call to

Switch Type

Generate Progress Tone to PSTN/PBX

Incoming Called Digits Size (0..255)

DID Service

Disable DID service

Enable DID service

Generate Progress Tone to IP

Send ALERT Message on Call Ringing

Enable CLIR Service

Enable Connect Acknowledge Option

P-Asserted-Identity

Disable P-Asserted-Identity

Override CLID with P-Asserted-Identity

Use Redirecting Number Info Element with P-Asserted-Identity

Please check your pending events!

Copyright (c) 2000-2012 Epagi Technologies, Ltd. All rights reserved.

Fig. I-52: Trunk T1 Signaling Type CCS page

If you selected CCS as your Signaling Type, using the **Trunk** link will take you to the page shown above. Here you can specify the signaling settings in more detail. Further, this page allows selection of the timeslots for signaling data and voice.

The **Non Automat** checkbox switches to non-automatic Terminal Endpoint Identifier (TEI) searching and enables the **TEI Address** text field that requires a TEI number (digit values from 0 to 63) for connection establishment between CO and E1/T1 client. In automatic mode, an E1/T1 connection will be established on the first available TEI, while in non-automatic mode a specific TEI may be reserved for the connection. In this case both call partners need to specify the same TEI in their settings.

In the **Network Mode** (PBX connected) you need to specify the same TEI address on both sides (Quadro and PBX), if the **Non Automat** mode is selected. If the **Automat** mode is selected the user on the PBX side may set any mode related to TEI assignment in the PBX configuration.

In the **User Mode** (CO/PSTN connected) the TEI assignment depends on the CO/PSTN settings. So you have to enter the values you've got from your PSTN provider.

The **SAPI Value** text field requires an additional Service Access Point Identifier (SAPI) value (digit values from 1 to 62) that is used to support additional interface between ISDN Layer 2 and Layer 3. Leaving this field empty (default value), only Call Control and Layer 2 management procedures will be activated.

The **Alternative Disconnection Mode** checkbox should not be selected, if Quadro ought to disconnect the call as soon as disconnect message has been received from the peer, otherwise, when checkbox is selected, Quadro's user may hear a busy tone when peer has been disconnected.

In the **ISDN L2 Timers** area the **Excessive Ack. Delay T200** text field configures the period in milliseconds (digit values from 500 to 9999) between transmitted signaling packet and its acknowledgement received. The **Idle Timer T203** text field configures the period in milliseconds (digit values from 1000 to 99999) for E1/T1 client idle timeout. The Service Provider provides these settings.

In the **ISDN L3 Timers** area, the **T302 Timer** text field requires the value for the T302 timer in milliseconds (digit values from 0 to 15000) and indicates the time frame system is waiting for a digit to be dialed and when timer expires, it initiates the call. The timer is not applicable for DMS-100 switch types. The **T309 Timer** text field requires the value for the T309 timer in milliseconds (digit values from 0 to 90000) responsible for call steadiness during link disconnection within the period equal to this timer value. If the value in this field is 0, the T309 timer will be disabled. The **T310 Timer** text field requires the value for the T310 timer in milliseconds (digit values from 1000 to 120000) responsible for the outgoing call steadiness when CALL PROCEEDING is already received from the destination but call confirmation (ALERT, CONNECT, DISC or PROGRESS) is not yet arrived. The **No Answer Disconnect Timer** text field is only available in Network mode and requires the value for the No Answer Disconnect Timer (digit values from 0 to 200000). This timer is used in certain types of PBXs. The value 0 indicates that the timer is disabled. When time expires, Quadro will play a busy tone towards the PBX if the call has been disconnected by the peer.

The **D Channel Timeslot For Transmit/Receive** drop down list in offers all available timeslots to be selected for signaling data transmit/receive.

The link **B Channels** leads to the **Signaling Type CCS - B Channel Settings** page (see below) where available timeslots may be enabled or disabled for the voice transfer. The **Force Update** option can be optionally used to apply new settings immediately. This will force the timeslot(s) to be restarted and any active connection on the selected timeslot(s) will be interrupted. The **Restart** option can be used to bring timeslot(s) to the initial idle state on the both sides. Note, that when applying one of these options, any active traffic on the timeslot(s) will be terminated. **Edit** will display another page, where the signaling settings for the selected timeslots may be specified in detail.

Bearer Establishment Procedure allows you to select the session initiation method on the B channels. One of the following possibilities of the transmission path completion prior to receipt of a call acceptance indication can be selected:

- on channel negotiation at the destination interface;
- on progress indication with in-band information;
- on call acceptance.

Called Party Type of Number and **Calling Party Type of Number** fields indicate correspondingly the type of the called party's and of the calling party's number.

Called Party Numbering Plan and **Calling Party Numbering Plan** drop down lists indicate correspondingly the numbering plan of the called party's and calling party's number.

The **Route Incoming Call** to drop down list contains Attendant, routing agent with two kinds of call routing possibilities, and all extensions of Quadro and allows selecting the des-

mination where incoming calls will be routed to. Choosing **Routing** will request the caller to pass the authentication (if enabled) and will invite him to dial the destination number to connect the user within the Quadro Network. Choosing **Routing with inbound destination number** will request the authentication (if enabled) and then will automatically use the initially dialed number to connect the destination without any additional dialing.

Attention: When Quadro acts in the Network mode with the Attendant as a destination to route the incoming calls to, digit forwarding should be disabled on the private PBX side otherwise incoming digits may be mistaken as a special calling codes on the Quadro's Attendant.

The value for **Switch Type** depends on the CO when acting in the User mode and the private PBX capabilities when acting in the Network mode.

Attention: A timeslot can be used either for voice or signaling data transfer. The configuration prevents the selection of a timeslot from the B channel list if it has already been selected from the **D Channel receive/transmit** drop down list.

The **Generate Progress Tone to PSTN/PBX** drop-down list contains the options for sending progress (ring-back) tone to callers from the PSTN/PBX. The following options are available in the list:

- **None** configures the system to send ALERT messages without the Progress Indicator information element (IE).
- **Unconditional** configures the system to send ALERT/PROGRESS messages with the Progress Indicator IE. With this option, the system will send its own progress tone.
- **Conditional** configures the system to send ALERT/PROGRESS messages with Progress Indicator IE. With this option, the system will send its own progress tone only if there is no early media (180/183 with SDP) from the called party.

Incoming Called Digits Size indicates the number of received digits (in a range from 0 to 255) required to establish a call. When field has 0 value, the system uses either the timeout defined in the T302 field or the **Sending Complete Information Element** messages to establish a call. Independent from the value in this field, **Sending Complete Information Element** and pound sign always cause call establishment.

DID Service:

- **Disable DID service** disables the DID service.
- **Enable DID service** enables the DID service. The **CCS DID Service** button leads to the **Trunk CCS DID Service** page where CCS DID number(s) may be configured.

The **CCS DID Service** page is used for mapping a group of DID numbers to the certain destinations on the Quadro.

To begin managing DID numbers, you must do the following:

In the **Start DID Number** and **End DID Number** text fields enter a range of DID numbers.

The **Start DID Number** field must indicate a shorter number than the **End DID number** field. Otherwise the following error message appears: "End DID number should be greater than Start DID number."

Select the destination from the **Incoming/Outgoing Call To/From** drop-down list where the incoming/outgoing call addressed to the certain DID numbers range will be routed.

The DID number can be assigned to the Quadro's extensions, to the Auto Attendant, or to the routing agent.

Choosing the **Routing with inbound destination number** selection will automatically use the initially dialed number to connect the destination without any additional dialing. The following functional buttons are available on this page:

- **Add** is used to add the range of DID numbers. Once the DID numbers have been added, you will see the extensions and their assigned DID numbers in the table below. For example, if you have inserted 1000 in the **Start DID number** text field and 1003 in the **End DID number** text field, then DID numbers 1000 1001, 1002 and 1003 will be added to the table.
- **Delete** is used to delete the DID numbers from the table with the selected range in the **Start DID Number** and **End DID Number** fields.
- **Delete All** is used to delete all DID numbers from the table at once.

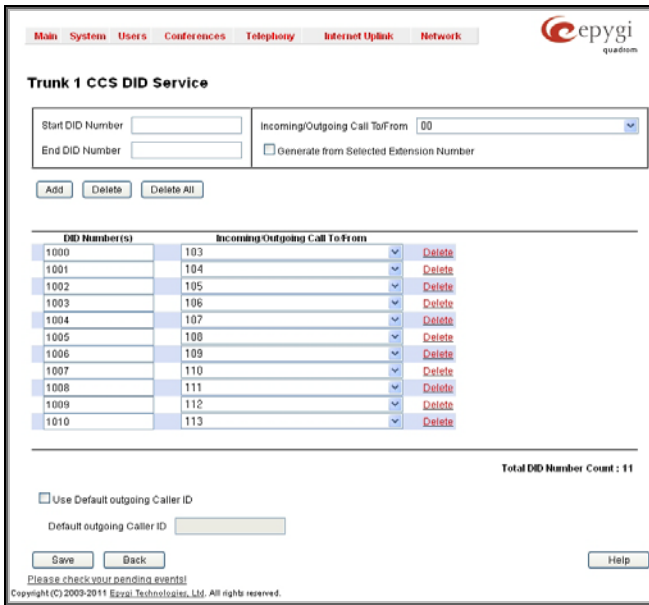

Fig. I-53: Trunk 1 CCS DID Service page

Please Note: You can add DID numbers of up to 20 digits long and up to 500 DID numbers can be specified.

To assign DID numbers to a consecutive extensions, choose an extension from the **Incoming/Outgoing Call To/From** drop-down list and select the **Generate from Selected Extension Number** checkbox. This will automatically assign DID numbers to a consecutive extensions starting from the selected extension.

Modify the fields in the table you wish to update and click the **Save** button.

Selecting the **Use Default outgoing Caller ID** allows you to overwrite the source caller information with the one specified in the **Default outgoing Caller ID** field when placing outgoing calls toward the CO, if the default caller ID does not match one(s) listed in the **Incoming/Outgoing Call To/From** field.

The **Default outgoing Caller ID** field requires the caller ID for the outgoing calls from the Quadro through the E1/T1 trunk. If this checkbox is enabled but no value is defined in the **Default outgoing Caller ID**, empty caller information will be sent to the CO. If this checkbox is disabled and the default caller ID does not match one(s) listed in the **Incoming/Outgoing Call To/From** field, source caller information will be forwarded to the CO.

The **Generate Progress tone on IP** checkbox selection will generate the progress tone to IP (H.323 or SIP).

If the **Send ALERT Message on Call Ringing** checkbox is selected, the system will send ALERT messages to callers from the PSTN/PBX on call ringing. If not, the system will send a PROGRESS message on receiving early media from the called party if the **Generate Progress Tone to PSTN/PBX** setting is not set to **None**.

Selecting the **Enable CLIR Service** checkbox enables the Calling Line Identification Restriction (CLIR) service which displays the incoming caller ID only if Presentation Indication is allowed on the remote side. Otherwise, if the CLIR service is disabled, the caller ID will be unconditionally displayed.

When the **Enable Connect Acknowledge Option** checkbox is selected, Quadro will stop the T303 and T310 timers upon receiving the CONNECT message, will send a CONNECT ACKNOWLEDGE message to the remote side and enter the active state. When this checkbox is not selected, Quadro will stop the T303 and T310 timers upon receiving the CONNECT message and will enter the active state without sending the CONNECT ACKNOWLEDGE message to the remote side.

P-Asserted-Identity:

The **Disable P-Asserted-Identity** radio button disables the P-Asserted-Identity feature for both incoming and outgoing calls.

The **Override CLID with P-Asserted-Identity** radio button selection enables the SIP P-Asserted-Identity support.

For the calls from SIP to E1/T1 if the Invite SIP message contains a P-Asserted-Identity or a P-Preferred-Identity or a Remote-Party-ID, then the CallerID on E1/T1 is sent with the original Caller ID which comes from the identity field. SIP user agent should check for the existence of the P-Asserted-Identity, then the P-Preferred-Identity, then the Remote-Party-ID to fill the identity field.

For the calls from E1/T1 to SIP with restricted Caller ID, the SIP Invite message contains P-Asserted-Identity field with the value from the Caller ID on E1/T1. The SIP From field contains anonymous.

The **Use Redirecting Number Info Element with P-Asserted-Identity** radio button selection enables full support of the SIP P-Asserted-Identity.

For the calls from SIP to E1/T1, if the SIP Invite message contains a P-Asserted-Identity or a P-Preferred-Identity or a Remote-Party-ID, then the CallerID on E1/T1 contains the number from the user name field and the Redirecting Number IE contains the original number from the identity field. SIP user agent should check for the existence of the P-Asserted-Identity, then the P-Preferred-Identity, then the Remote-Party-ID to fill the identity field. For the calls from E1/T1 to SIP with Caller ID, the SIP Invite message contains P-Asserted-Identity field with the original number value from the Redirecting Number IE on E1/T1. The SIP From field contains the value from the user name.

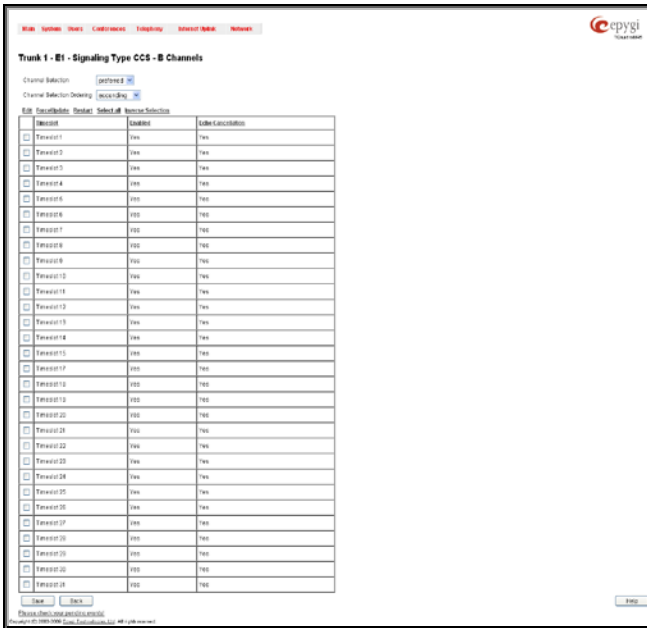

Fig. I-54: Trunk T1 Signaling Type CCS - B-Channels page

Channel Selection drop down list is used to select between the **Preferred** and **Exclusive** B channel selection methods. For **Preferred** channel selection, the CO answers to the call request by the first available timeslot, while for **Exclusive** channel selection CO should feedback only by the timeslot used for the call request.

Channel Selection Ordering drop down list is used to choose the B channels selection (Ascending or Descending). When **Ascending** selection is configured, B channels will be defined starting from B1 to B23/B30. For **Descending** selection, B channels will be defined from B23/30 to B1. If your CO/PBX has **Ascending** B channels selection configured, it is recommended to use **Descending** B channels selection and vice versa.

Please Note: A timeslot can be used either for voice or data transfer. The system prevents selecting a timeslot from the B channel list if it has already been selected from the D Channel receive/transmit drop down list.

Edit will display the first page of the CAS signaling Wizard page (see below), which contains 3 checkboxes:

- **Enable Timeslot** – used to enable/disable the selected timeslot(s);
- **Force Update Timeslot** – used to apply new settings immediately by restarting the timeslot(s);
- **Enable Echo Cancellation** – used to enable/disable the echo cancellation feature on the selected timeslot(s).

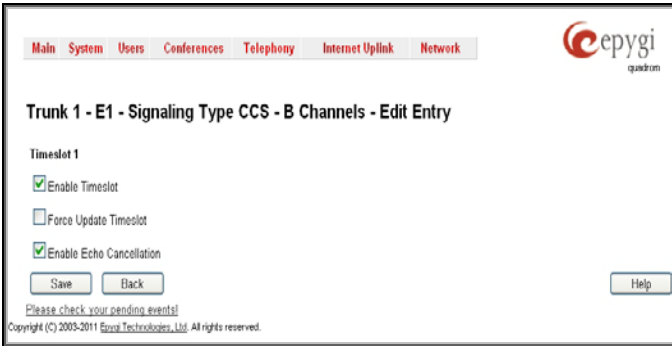

Fig. I-55: Trunk T1 Signaling Type CCS - B-Channels Edit page

Signaling Type CAS

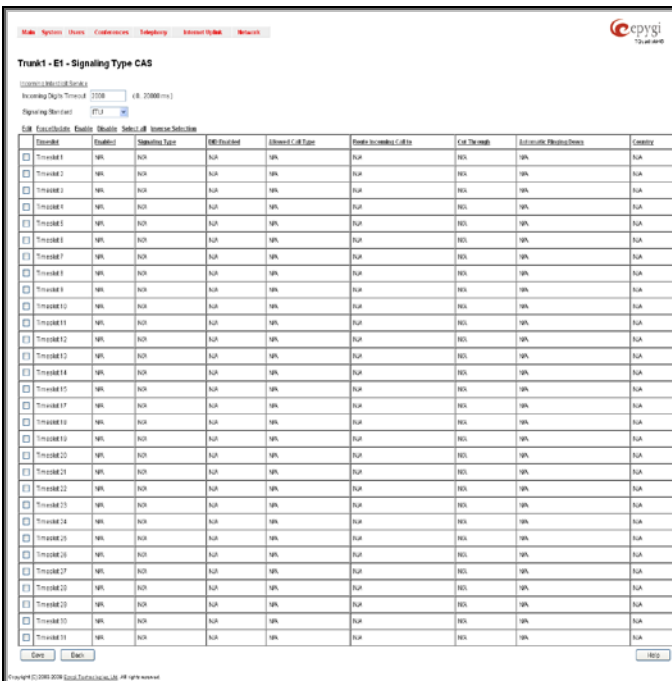

Fig. I-56: Trunk T1 Signaling Type CAS page

If you selected **CAS** as your **Signaling Type** on the **Trunk Settings - Edit Entry** page, you will get the page shown above using the **Trunk** link.

The **Incoming Interdigit Service** link leads to the page where the dial plan for incoming E1/T1 calls from CO/PBX to the Quadro can be configured. The **Incoming Interdigit Service** is used to configure E1/T1 dial plan for the incoming calls from CO/PBX to the Quadro. This service allows you to speed up the call establishment procedure by detecting the prefix. The calls will be speed up by the timeout defined in the **Incoming Digits Timeout** text field (see below). Consult with your CO before making changes in the E1/T1 dial plan.

In the **Incoming Digits Timeout** text field the time period may be specified, during which incoming digits from the destination party calling Quadro will be collected before being applied as an incoming called number. Values between 0 and 20000 (in milliseconds) are required.

The **Signaling Standard** drop down list is available only in E1 mode and allows selecting the connection signaling standard (ITU, ITU_T_2 or MELCAS).

In the table below, the page lists all timeslots. To configure the timeslots, select one or more records from the table and press **Edit** functional button. This will open **CAS Signaling Wizard** where timeslot settings might be configured.

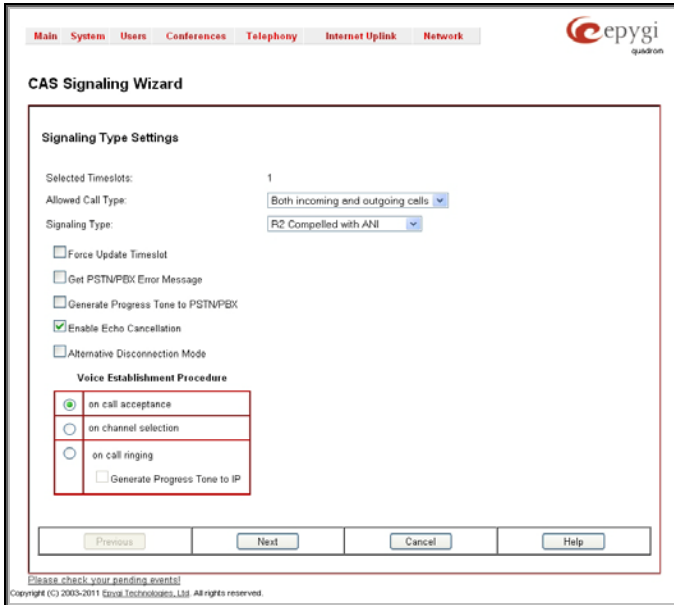

Fig. I-57: CAS Signaling Wizard - Page 1

From the first page, signaling type settings of the timeslot(s) might be configured:

Allowed Call Type is used to select the allowed call directions: incoming, outgoing or both.

Signaling Type allows selecting the CAS signaling type.

Please Note: R2 signaling (compelled and non-compelled) can only be used with an E1 interface in User mode. Independent on the selection in this drop down list, Quadro with the T1 interface in the CAS mode is unable to detect the busy tone on the destination side. For E1 interface in the CAS mode, busy tone will be detected only for R2 compelled and non-compelled (both with and without ANI) signaling types.

Force Update Timeslots checkbox can be optionally selected in order to apply new settings immediately. This will force the timeslot(s) to be restarted and any active connection on the selected timeslot(s) will be interrupted.

Please Note: Quadro does not support the **Forward Digit** selected on the CO when acting in the **User** mode with **CAS Loop Start** signaling type.

Get PSTN/PBX Error Message checkbox enables notification message in case of outgoing calls to unreachable, incorrect or non-existent destination.

When **Generate Progress Tone to PSTN/PBX** checkbox is selected, Quadro generates ring tones to incoming callers during E1/T1 call dialing. This feature is mainly applicable to 2-stage dialing mode.

Enable Echo Cancellation checkbox enables the echo cancellation mechanism on the selected timeslot(s).

When **Alternative Disconnection Mode** checkbox is selected, the Quadro will play a busy tone towards the PBX/CO if the call has been failed. After 60 second timeout, the Quadro will disconnect the call from PBX/CO and will stop playing the busy tone.

Voice Establishment Procedure manipulation radio buttons group is used to select a method of voice establishment on the trunk.

- **On call acceptance** – with this selection, voice will be established after call is being accepted.
- **On channel selection** - with this selection, call will be accepted during channel selection. This selection is not allowed for R2 signaling.
- **On call ringing** - with this selection, voice will be established after call is being ringing. Selection enables **Generate Progress Tone to IP** checkbox which is used to enable the progress tone generation upon voice establishment.

Press **Next** to move to the second page of the **CAS Signaling Wizard**:

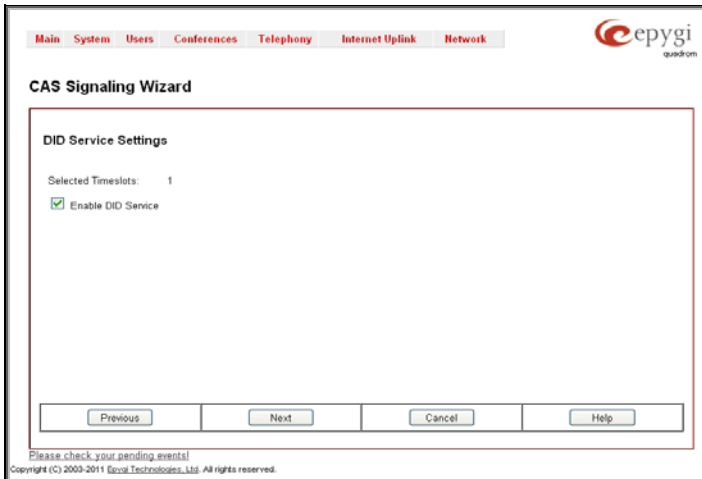

Fig. I-58: CAS Signaling Wizard - Page 2

CAS Signaling Wizard - Page 2 appears if the **Signaling Type** on the previous page is set to any of the **E&M** types or to **R2 DTMF**. From this page of the CAS Signaling Wizard, **DID (Direct Inward Dialing) Service** might be enabled on the timeslot(s).

In **User** mode, the Quadro cannot route incoming calls from the E1/T1 trunk to extensions if the timeslot in the trunk does not have DID service enabled. Incoming call routing takes place according to the received caller ID. If the DID service is enabled on some timeslot(s), an incoming call on these timeslots may be routed to the specified extension, the Attendant, or the routing client (depending on the configuration).

Please Note: The timeslot with DID service enabled cannot be used for outgoing calls.

In **Network** mode DID service does not limit the Quadro functionality but a timeslot with

enabled DID service cannot be used for incoming calls.

Please Note: The CO/private PBX must support the DID service, if it is to be configured on the QuadroM32x.

Press **Next** to move to the third page of the **CAS Signaling Wizard**:

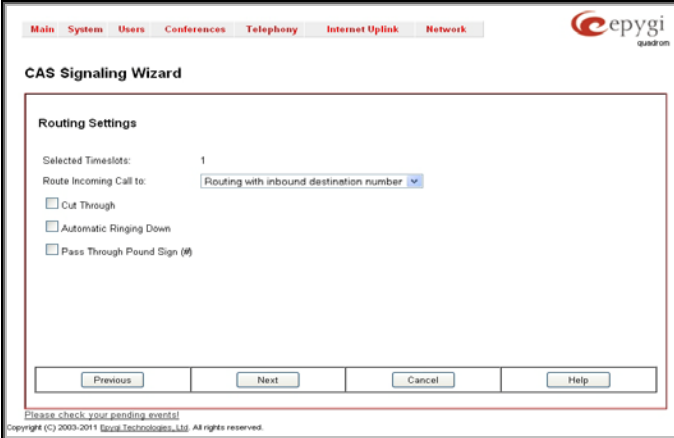

Fig. I-59: CAS Signaling Wizard - Page 3

From this page, the destination for incoming calls to be routed to can be selected and other routing settings might be configured.

Route Incoming Call to drop down appears when **Both incoming and outgoing calls** or **Incoming calls only** is selected from the **Allowed Call Type** list and allows selecting the destination where incoming calls should be routed. The list contains all extensions of the Quadro, Attendant and Routing agent. Choosing the **Routing with inbound destination number** selection will automatically use the initially dialed number to connect the destination without any additional dialing.

When **DID service** is enabled (in User mode only), incoming calls can be only routed to the Routing agent with simple **Routing** and **Routing with inbound destination number** call routing possibilities.

Attention: When Quadro acts in the Network mode with the Attendant as a destination to route the incoming calls, digit forwarding should be disabled on the PBX side. Otherwise, incoming digits may be mistaken as special calling codes on the Quadro's Attendant.

Cut Through checkbox is available when signaling selected from the **Signaling Type** drop down list on the **CAS Signaling Wizard – Page 2** is different from R2 (all types) and is used to reconnect the call (terminated by some reason, e.g. user error, network problems, etc.) by going on-hook and off-hook again even if the call partner is off-hook and not involved in the call.

Automat Ringing Down checkbox is available when signaling selected from the **Signaling Type** drop down list on the **CAS Signaling Wizard – Page 2** is different from R2 (all types) and allows an E1/T1 device connected to the Quadro to establish a hot-line call (automatic call without any digits dialed).

Pass Through Pound Sign (#) checkbox is only available when signaling selected from the **Signaling Type** drop down list on the **CAS Signaling Wizard – Page 2** is different from E&M FGD or R2 (except for R2-DTMF). When this checkbox is selected, the pound sign (#) detected in the dialed number will be passed through and will be considered as a part of the dialed number. When this checkbox is not selected, the detected pound sign (#) will be considered as a call acceleration digit.

Press **Next** to move to the forth page of the **CAS Signaling Wizard**:

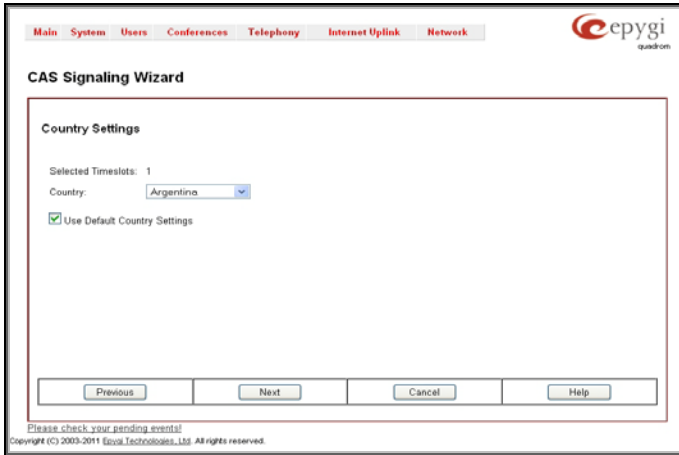

Fig. I-60: CAS Signaling Wizard - page 4

This page only appears in E1 User mode when signaling selected from **Signaling Type** drop down list on the **CAS Signaling Wizard – Page 2** is R2 (all types) and is used to configure country settings.

Country drop down list is used to set the location where Quadro is located to support the correct functionality of R2 signaling. For countries absent in this list, use **ITU** selection.

Use Default Country Settings checkbox restores default advanced settings for the selected country. When this checkbox is not selected, next page will provide a possibility to manually configure advanced country settings.

Press **Next** to move to the fifth page of the **CAS Signaling Wizard**:

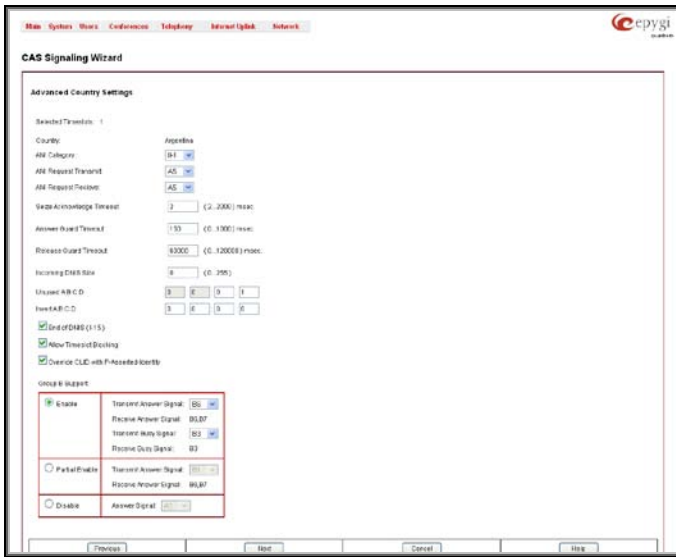

Fig. I-61: CAS Signaling Wizard - page 5

This page only appears when **Use Default Country Settings** checkbox is not selected on the previous page and is used to configure advanced country settings.

ANI Category drop down list appears only when **R2** signaling selected from **Signaling Type** drop down list on the **CAS Signaling Wizard – Page 2** is different from **R2 DTMF** and is used to select the calling party priority depending on the call originator's location specifics.

ANI Request Transmit and **ANI Request Receive** drop down lists allow you to select the Caller ID request R2 tones for transmit and receive.

Seize Acknowledge Timeout text field is used to define a timeout (in a range from 2 to 2000 milliseconds) between incoming seize signal and the corresponding feedback.

Answer Guard Timeout text field is used to define a wait timeout (in a range from 0 to 1000 milliseconds) Group-B Answer Signal and Line Answer.

Release Guard Timeout text field is used to define an idle timeout (in a range from 0 to 10000 milliseconds) between the disconnect signal receipt and call disconnection.

Dialing Delay Timeout text field is used to define a timeout (in a range from 0 to 2000 milliseconds) before injecting dialed digits. Timeout specially refers to R2 DTMF signaling.

Incoming DNIS Size text field indicates the number of received digits (in a range from 0 to 255) required to establish a call. When this field has a "0" value, the system uses either timeout, defined in the **Incoming digits timeout** field or the **End of Address** messages to establish a call. Independent on the value in this field, the message **End of Address** always causes the call establishment.

Unused A:B:C:D text fields require to configure unused C and D bits of E1/T1 CAS signal-

ing (A and B bits are predefined). Fields may have either 0 or 1 values.

Invert A:B:C:D text fields are used to invert the ABCD status bits in time-slot 16 before TX and after RX. If bit is set to 1, the router inverts it before transmission and after the receipt.

End of DNIS (I-15) checkbox is used to enable End of DNIS service.

Collect Call checkbox is only available when **Brazil** is selected in the **Country** drop down list on the previous page of the wizard and when the PBX attached to the Quadro supports this feature. When this checkbox is selected and in case of incoming calls, always the called destination will pay for the call. Option is particularly applicable when calling from the mobile phone. Checkbox should be selected when the appropriate feature is enabled on the PBX.

Group B Support manipulation radio button group is present only when **R2** signaling selected from **Signaling Type** drop down list on the previous page is different from **R2 DTMF** and is used to enable/disable the **Group B Support**. The **Group B Support** manipulation radio button group offers following selections:

- **Enable** – this selection enables **Group B Support** both for answer and busy recognitions of transmit and receive signals. This selection requires you to define transmit and receive signals. The **Transmit Answer Signal** and **Transmit Busy Signal** parameters are defined from the drop down lists on this page. When transmit signals are selected, press **Next** on this page to access the **R2 Receive Signal Settings** page where **Receive Answer Signal** and **Receive Busy Signal** should be defined. Use the checkboxes to select the **Receive Answer Signal** and **Receive Busy Signal** values. Multiple values are allowed for each signal.

Please Note: Warning appears if you have selected the same signal type both for receive answer and receive busy recognitions.

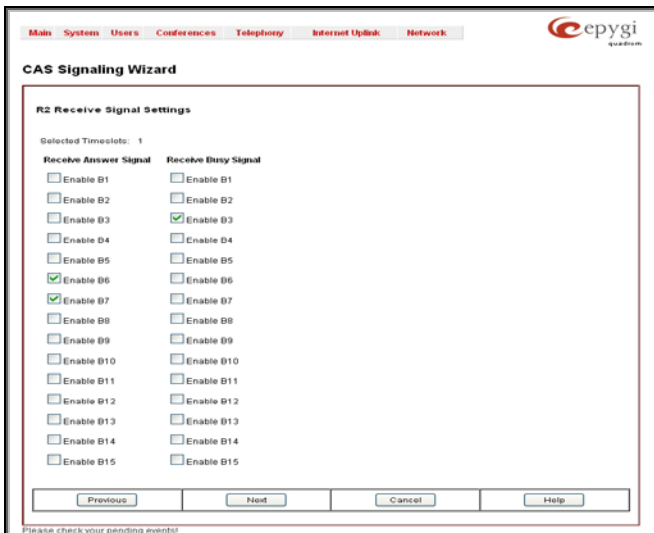

Fig. I-62: CAS Signaling Wizard - Receive Signal Settings page

- **Partial Enable** – selection partially enables **Group B Support** with for answer recognition only. This selection requires you to define transmit and receive signals. The **Transmit Answer Signal** parameter is defined from the drop down list on this page. When transmit signal is selected, press **Next** on this page to access the **R2 Receive Signal Settings** page where **Receive Answer Signal** should be defined. Use the checkboxes to select the **Receive Answer Signal** value. Multiple values are allowed for each signal.
- **Disable** – selection disables **Group B Support** and requires defining the **Answer Signal** parameter.

Step 3: Registering on Epygi's Technical Support

It is recommended that you register your Quadro on the Epygi Technical Support web page. Registration will give you access to the Technical Support Database. There, you can submit requests concerning technical problems as well as refer to the Frequently Asked Questions (FAQ) section. In addition, the technical support page allows users to download new firmware, manuals and other information. You can access the support section only if you are registered. Additionally, registration at Epygi's Technical Support web page gives you the username and password to login to the Epygi SIP Server.

To register, you need to know the serial number of your Quadro, which is located on a label on the bottom of Quadro. You will also need the date of purchase. Next, open the Epygi home page (www.epygi.com), select **Support** and click on **Registration Form**. The online registration page will appear:

Fig. I-63: Registration form

Complete all fields and record the **Login Name** and **Password** in a safe place. You will need it for the SIP server.

Please Note: In some cases, the Quadro units will be shipped preconfigured from the factory with the Support login and password already set up. In this case, an information sheet is included in the packaged contents indicating the username and password to access Epygi's Online Support and the Epygi SIP Server.

Appendix: Changing the Admin Password

For security reasons, it is recommended that you change the default admin password. The username of the administrator (**admin**) cannot be changed.

To change the administrator password, go to the **System** menu, **User Rights Management**.

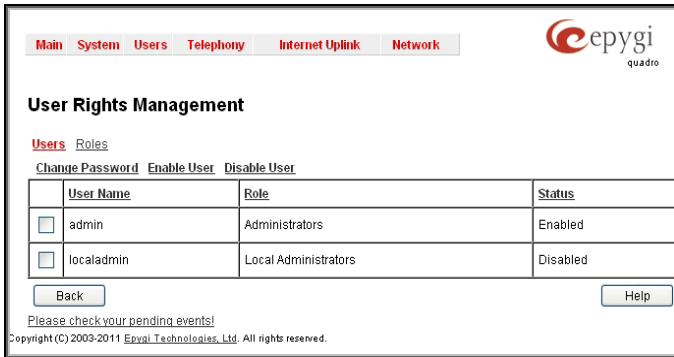

Fig. I-64: User Right Management page

Choose **admin** from the list and press the **Change Password** functional button from the **User Right Management** page toolbar.

For **Administrator** account the page contains two parts - one for **GUI Access Password**, the other one for **Phone Access Password**.

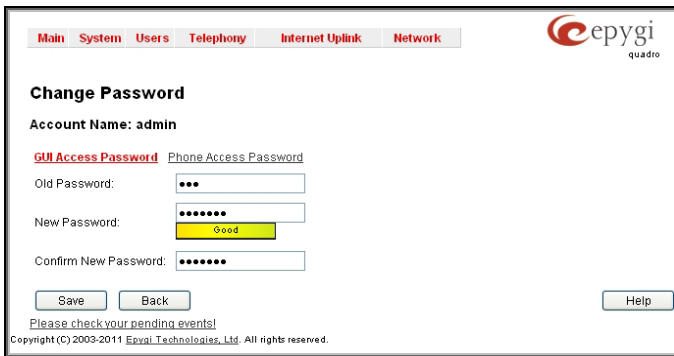

Fig. I-65: Change Password page

The **GUI Access Password** offers the following components:

- The **Old Password** field requires the current password of the **Administrator**. An error message prevents entering the wrong password.
- The **New Password** field requires a new password for the **Administrator**. Reentering the new password in the **Confirm New Password** field will confirm the new password. The **New Password** field is checked against its strength and you may see how strong is your inserted password right below that field. Up to twenty (0-20) digits and symbols are allowed.

Fig. I-66: Change Password page

The **Phone Access Password** offers the following components:

- The **Old Password** field requires the current password of the **Administrator**. An error message prevents entering the wrong password.
- The **New Password** field requires a new password for the **Administrator**. Reentering the new password in the **Confirm New Password** field will confirm the new password. The **New Password** field is checked against its strength and you may see how strong is your inserted password right below that field. The password can consist of numeric values only. Up to twenty (0-20) digits are allowed. A corresponding warning appears if any other symbols are inserted.

Please Note: If **Administrator** is changing the **Local Administrator** or **Extension** passwords or **Local Administrator** is changing the **Extension** password then the **Old Password** field is not displaying.

Attention: It is highly recommended to define a proper and non-empty password on this page if the extension is being used for the Call Relay service from the Quadro's [Auto Attendant](#).

Write down the password somewhere and keep it in a secure place. If the password is lost, a factory reset will be required on the unit (see Administrator's Guide, Hardware Overview). All settings are lost after a factory reset. After a factory reset the default password (19) will be restored.

Appendix: Configuring NAT Traversal

NAT or Network Address Translation is a common feature used to expand the use of connected PCs and other networked devices without having to use multiple global Internet public IP addresses. Most ISP's will assign one public IP address to each customer that is connected to the Internet. The customer can use a router to provide NAT capability and create a private network of PCs and other devices not visible from the Internet. This method offers security and also eliminates the need to assign global Internet public IP addresses to each device on the LAN.

The Quadro initiates and receives SIP calls from the Internet (or the network connected to the WAN port). To receive SIP calls, the Quadro must be able to receive packets from the SIP server or any other device that is trying to make an incoming call. If the Quadro is placed behind a router with NAT, like most basic routers on the market today, the Quadro will not be able to receive calls. To resolve this issue, either STUN must be enabled on the Quadro or SIP NAT traversal must be set up in the router and in the Quadro to route the incoming calls properly.

Please Note: NAT traversal only works with Internet connections that have static IP addresses. Verify from your provider that this is the case for your Internet connection. Some ISPs provide dynamic IP addresses that may change from time to time, and are not appropriate for SIP NAT traversal.

Please Note: If you have more than one router in series between the Quadro and the Internet, the same port forwarding setup must be configured on each router.

NAT Traversal Setup

- Install the Quadro behind the router. If the Quadro is configured with its factory default settings, it is already configured for DHCP and will obtain an IP address automatically from the router.
- Connect a PC to the Quadro LAN port and power it up.
- Verify the Quadro can connect to the Internet by opening a browser window and browsing to a familiar WEB site. If the Quadro cannot reach the Internet, verify the LAN/WAN LEDs and the cabling. Verify the Quadro is set up for DHCP on the WAN and that the router has the DHCP server enabled for the devices behind it.
- Find the address of the router and log into the router. Refer to the router's user manual on how to open the router configuration.
- Set up port forwarding on the router to forward UDP ports 5060, 6000-6099 to the IP address assigned to the Quadro. You can see the IP address of the Quadro in the **System** menu under **Status**, submenu **Network Status**. The IP address will be listed as the WAN IP address. Your router also may indicate the IP address assigned to the Quadro.
- Find out the public Internet address (WAN IP address) of the router. To do so, open a browser and go to www.whatismyip.com. The site will return your public Internet IP address. Record this IP address.
- From the **Telephony** menu of the Quadro Management go to the **NAT Traversal Settings** page, go to **General Settings** and set the enable **NAT Traversal for SIP** radio buttons selection to **Force**. **Save** the selection.

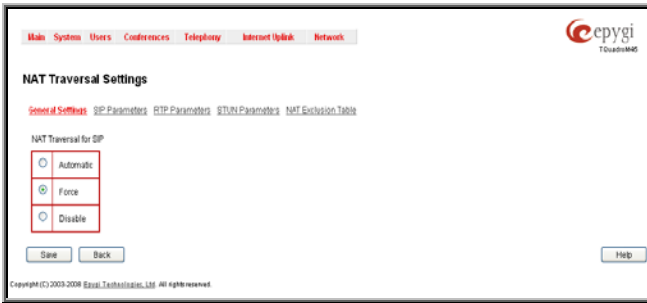

Fig. I-67: NAT Traversal Settings – General Settings

Go to **SIP Parameters** page.



Fig. I-68: NAT Traversal Settings - SIP Parameters

Select **Use Manual NAT Traversal** and enter the WAN IP address of the router into the **Mapped Host** text field. For **Mapped Port**, enter the router's corresponding port number, in this case **5060**. **Save** the entries.

- Go to the **RTP Parameters** page and select **Use Manual NAT Traversal**.

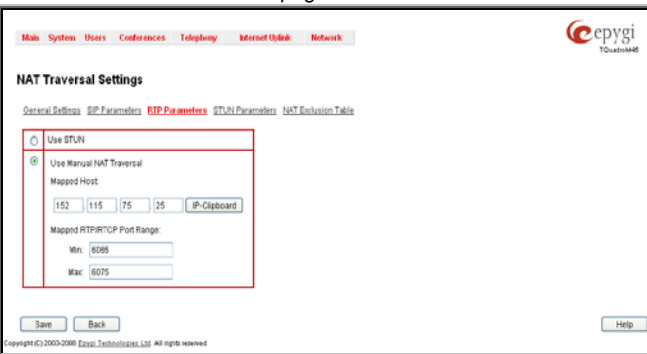

Fig. I-69: NAT Traversal Settings - RTP Parameters

- Enter the WAN IP address of the router into the **Mapped Host** text field. Set the **Mapped RTP/RTCP Port Range** according to the values specified on the router, in this case to **6000 (Min)** and **6199 (Max)**, respectively. Click the **Save** button to save the contents.

The Quadro will activate the settings and register the extensions on the Epygi SIP Server after a few minutes. You can verify the settings from the main **Quadro Management** menu under **Status** in the **SIP Registration Status** section.

Appendix: Registering on Epygi's SIP Server

Epygi maintains a SIP Server that can be used to call between Quadro devices. Quadro extensions may already be defaulted to register to the SIP Server. To create additional registrations you may login directly to Epygi's SIP Server if you have registered your Quadro at [Epygi's Technical Support Center](#). If you have not registered with Epygi Technical Support, you cannot login to the Epygi SIP Server.

Log in to the Epygi SIP Server at www.epygi.com. Click on **SIP Server Login**. Use the same login name and password you used for Epygi Support for Customer Login.

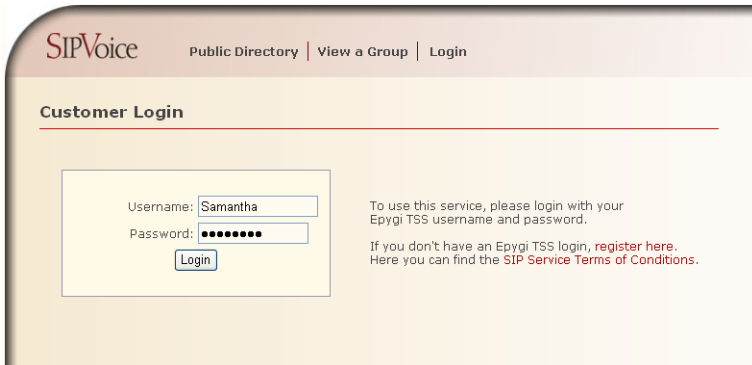

Fig. I-70: SIP Services Login page

Read the **SIP Service Terms and Conditions** and accept it to proceed. The displayed page now welcomes you and allows you to **Subscribe a New Extension**.

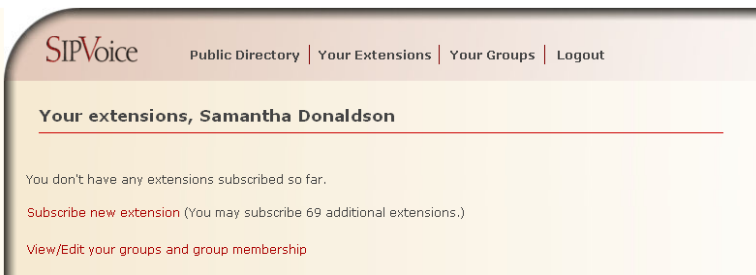

Fig. I-71: SIP Services Welcome page

Selecting **Subscribe a New Extension** leads you to a page where you can enter the user information as shown below. The **Extension Nr.** is the eight-digit SIP number assigned to your extension. The first five are fixed by the SIP Server and cannot be changed and the last three are user defined. Notice the check box to enable this extension to be shown in the Epygi **Public SIP Directory**.

Please Note: If you enable this extension to be shown in the Epygi **Public SIP Directory**, all information related to this extension will be published in the Public SIP Directory, which is accessible by anyone from the Internet. To maintain privacy, do not check this box.

Fig. I-72: SIP Services Add New Extension page

The **Authentication password** validates the entry and must match the password entered on the Quadro later. Make sure to record the name, Authentication Password and SIP extension number for entry into the Quadro later.

Save will store the entered information and conclude the basic SIP registration. The following page then will be displayed:

EXT. #	STAT. ?	NAME	LOCATION	COMPANY	DESCRIPTION	EMAIL	PUB	? GROUPS ?
edit 30256321	unreg.	Samantha Donaldson	Seattle	OmniTec, Ltd.	Headquarters	yes	-	delete

[Subscribe new extension](#) (You may subscribe 9 additional extensions.)

[View/Edit your groups and group membership](#)

Fig. I-73: SIP Services Your Extension page

This table shows **unreg.** in the **Stat.** column. This entry will change to **reg.** when the required settings in the Quadro are complete and the Quadro successfully registers on the SIP Server.

Repeat this for all four extensions on the Quadro and the Auto Attendant.

Configuring Quadro Extensions

Once the SIP server has the created extensions with the user information, create these extensions in the Quadro devices. Once they are entered in the Quadro, they will be registered and can then be used.

Login to the Quadro and go to **Extensions Management**.

Extensions Management

Extension	Display Name	Attached Line	SIP Address	Percentage of System Memory	External Access	Codec
<input type="checkbox"/> 00	Attendant		741800@sip.epygi.loc:5060	1% (1 hour 23 min 51 sec)		PCMU...
<input type="checkbox"/> 02			741810@sip.epygi.loc:5060	0.5% (41 min 55 sec)		PCMU...
<input type="checkbox"/> 101		Line 1	7418101@sip.epygi.loc:5060	1% (1 hour 23 min 51 sec)	None	PCMU...
<input type="checkbox"/> 102		Line 2	7418102@sip.epygi.loc:5060	1% (1 hour 23 min 51 sec)	None	PCMU...
<input type="checkbox"/> 103		IP Line 1	7418103@sip.epygi.loc:5060	0.4% (33 min 32 sec)	None	PCMU...
<input type="checkbox"/> 104		IP Line 2	7418104@sip.epygi.loc:5060	0.4% (33 min 32 sec)	None	PCMU...
<input type="checkbox"/> 105		IP Line 3	105	0.4% (33 min 32 sec)	None	PCMU...
<input type="checkbox"/> 106		IP Line 4	7418106@sip.epygi.loc:5060	1% (1 hour 23 min 51 sec)	None	PCMU...

Unified Universal Extension Recordings
Add Multiple Extensions
Back Help

Please check your pending events!
Copyright (C) 2009-2019 Epygi Technologies, Ltd. All rights reserved.

Fig. I-74: Extensions Management page

Select the first extension to change by clicking the appropriate checkbox and press **Edit** functional button. The **Extensions Management – Edit Entry** page will be displayed.

Go to the **General Settings** page and adjust the **Display Name** as needed.

Extensions Management - Edit Entry

General Settings - 104

Display Name / Subject: John Smith

Password: ***** [Generate Password](#)

Confirm Password: *****

Attached Line: IP Line 2

Use Kickback

Allow Call Relay

GUI Login Allowed

3pccChoc2Dial Access Allowed

Show on Public Directory

Percentage of Total Memory: 2 %

Allow other users to Barge in to this extension

[Edit Call Barge In/Intercept Access List](#)

[Edit Watch Access List](#)

Save Back Help

Please check your pending events!
Copyright (C) 2009-2019 Epygi Technologies, Ltd. All rights reserved.

Fig. I-75: Extensions Management - Edit Entry – General Settings page

Go to the **SIP Settings** page to enter the **SIP Registration Settings** you received from the Epygi SIP server.

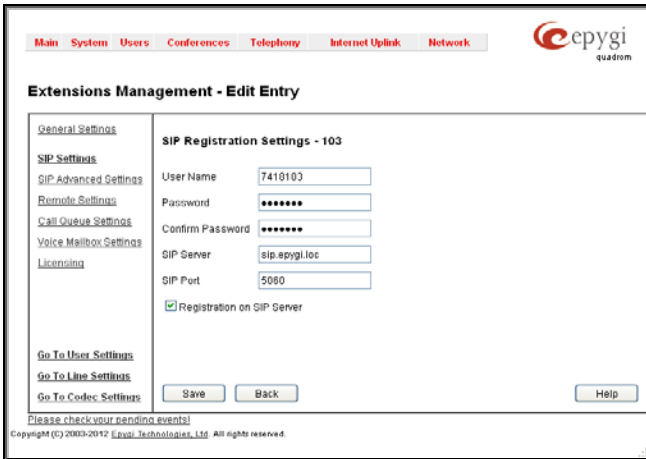

Fig. I-76: Extensions Management - Edit Entry – SIP Settings page

- Enter the SIP registration number displayed in the column **Ext#** into the text field **Registration User Name**.
- In the **Password** field, enter the password you specified when registering at the SIP server and confirm it in the field below.
- In **Registration SIP Server**, the selected SIP server address must be entered. If you use the Epygi SIP server, you may enter **sip.epygi.com**.
- Most SIP server providers, including Epygi, use port 5060 as the **Registration SIP Port**. You may leave the default entry as is.
- Select **Registration on SIP Server** if you want to establish and receive IP calls.
- Click the **Save** button to activate the settings.

Other settings of the extension might be also modified from **Extensions Management – Edit Entry** page (refer to the Manual II - Administrator’s Guide).

Your settings will be verified, then after a few seconds the **Extensions Management** page is updated with the changes as shown in the below example, Fig. I-77.

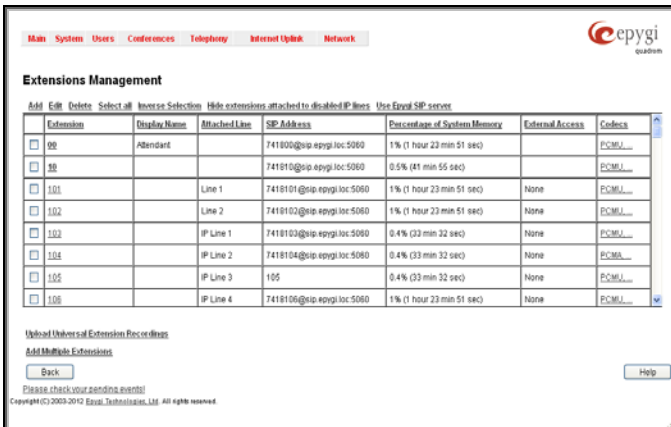

Fig. I-77: Extensions Management page

If you go back to Epygi's SIP Server, you will find the value **reg.** for this number in the column **Stat. Reg.** This indicates that the Quadro has successfully registered the new number. If this does not happen after a few minutes, again verify the SIP Number and passwords.

Appendix: Checking the Connections

If the system doesn't seem to be working properly, even when all the cables are connected properly, it may be helpful to **Start Network Diagnostics**: The WAN link, IP configuration, gateway, DNS server, and STUN-NAT will all be checked.

To start diagnostics, open the **System's** menu item **Diagnostics** and click **Start Network Diagnostics**.

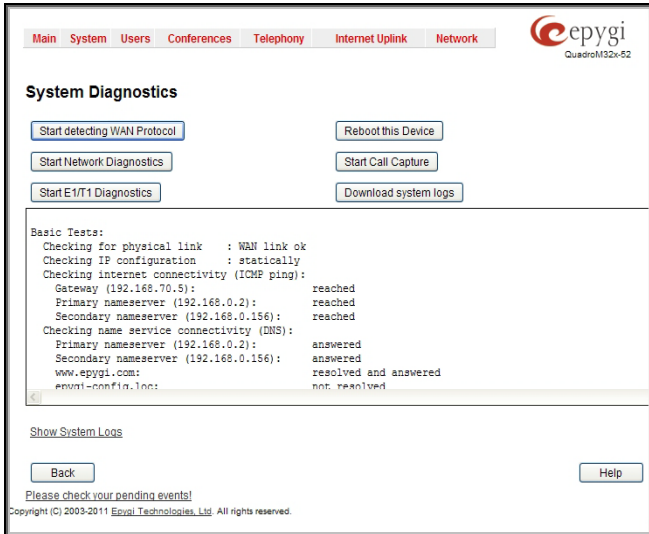

Fig. I-78: System Diagnostics - Network Diagnostics page

If the test passes, the output of the system may look as follows:

Basic Tests:

```

Checking for physical link:           WAN link ok
Checking IP configuration:           dynamically via DHCP Client
DHCP Client is running
Checking internet connectivity (ICMP ping):
Gateway:                             reached
Primary nameserver:                  reached
Secondary nameserver:                not configured
www.epygi.com:                      reached
STUN Network Address Translation (NAT) Check:
External visible address: 212.126.210.179
Detected NAT type                   : Restricted cone
Performing MTU Discovery:
preparing system
Sending UDP Datagram of size 1500    got answer
clean up
Largest usable MTU size is: 1500 Bytes
Test successful.
  
```

Depending on where the test is failing, the diagnostic can give some advice on how to solve the problem. See the example below of a failed test:

Basic Tests:

```

Checking for physical link:           no WAN link
  
```

Please check the physical connection of the WAN interface. Cable not plugged or broken?

Test failed.

If diagnostics are successful, but you are still unable to place a call to 899# then check the SIP registration status.

Open the SIP Registration Status page using the Quadro management **System** menu item **Status**. Besides the SIP registration information for the auto attendant and each connected extension, the **Detected Connection Type** is shown. If Quadro is placed behind a NAT router and the STUN is enabled, the detected connection type and the IP address of this router's WAN port are displayed.

Quadro Status - SIP Registration Status

Registration on SIP Servers

Extension	EBox Name	Service	Registered	Registration Time
07	077505041	sip@pygi.com	Yes	07-Sep-2007 15:01:15
10	223710	sip.pygi.com	Yes	07-Sep-2007 15:10:23
00	223700	sip.pygi.com	Yes	07-Sep-2007 15:10:22
30	223730	sip.pygi.com	Yes	07-Sep-2007 15:10:23
27	223727	sip.pygi.com	Yes	07-Sep-2007 15:10:23
20	223738	sip.pygi.com	Yes	07-Sep-2007 15:10:23
25	223725	sip.pygi.com	Yes	07-Sep-2007 15:10:22
24	223724	sip.pygi.com	Yes	07-Sep-2007 15:10:22
23	223723	sip.pygi.com	Yes	07-Sep-2007 15:10:23
22	223722	sip.pygi.com	Yes	07-Sep-2007 15:10:23
21	223721	sip.pygi.com	Yes	07-Sep-2007 15:10:22
20	223720	sip.pygi.com	Yes	07-Sep-2007 15:10:23
12	223717	sip.pygi.com	Yes	07-Sep-2007 15:10:23
1A	223714	sip.pygi.com	Yes	07-Sep-2007 15:10:23
13	223713	sip.pygi.com	Yes	07-Sep-2007 15:10:22
12	223712	sip.pygi.com	Yes	07-Sep-2007 15:10:23
11	223711	sip.pygi.com	Yes	07-Sep-2007 15:10:23

Detected connection type: Full Cone NAT (external IP: 83.138.17.136:8122)

SIP Tunnels to SBCs Devices

Tunnel Name	Master Device IP	Master Device Port	Registration State	Registration Date/Time
SIP_Tunnel_221215	192.168.25.221	5079	Registered	03/06/2007 12:50:12
SIP_Tunnel_100	192.168.75.100	5176	Registered	03/05/2007 12:38:05
SIP_Tunnel_05_70			Not Registered	N/A
SIP_Tunnel_mch16			Not Registered	N/A

SIP Tunnels to Master Devices

Tunnel Name	Master Device IP	Master Device Port	Registration State	Registration Date/Time
SIP_Tunnel264	192.168.05.24	5081	Not Registered	N/A

Fig. I-79: SIP Registration Status page

Quadro cannot work behind your router if **Detected Connection Type** is one of the following:

- Unknown connection - unexpected error
- Symmetric NAT
- Symmetric Firewall
- Blocked UDP

If you get one of the above mentioned Detected Connection Types, either connect the Quadro in front of the router, or configure NAT traversal manually as explained in [Appendix: Configuring NAT Traversal](#).

If you are unable to resolve your problems, please send us a technical support request on the **Support** section of <http://www.pygi.com/>. Please prepare a system log file and attach it to your request.

To download the system logs, open the **System Diagnostics** page **System** menu item **Diagnostics** and click **Download System Logs**.

Appendix: Pin Assignment of ISDN

Pin	Signal
1	N.C.
2	N.C.
3	SSR1
4	SSX1
5	SSX2
6	SSR2
7	N.C.
8	N.C.

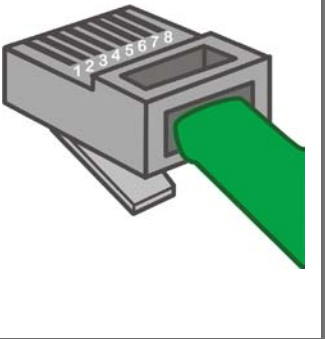

Fig. I-80: Pin Assignment of ISDN in User mode

Pin	Signal
1	N.C.
2	N.C.
3	SSX1
4	SSR1
5	SSR2
6	SSX2
7	N.C.
8	N.C.

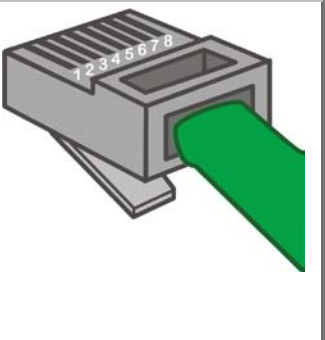

Fig. I-81: Pin Assignment of ISDN in Network mode

Appendix: Pin Assignment of E1/T1

Pin	Signal
1	RXRING
2	RXTIP
3	N.C.
4	TXRING
5	TXTIP
6	N.C.
7	N.C.
8	N.C.

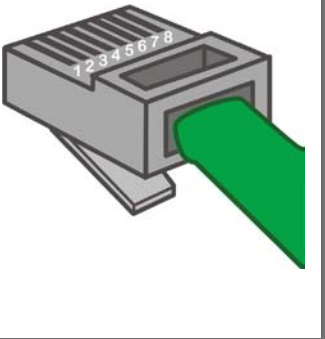

Fig. I-82: Pin Assignment of E1/T1

Appendix: Pin Assignment of RJ21

Pin (Tip)	Pin (Ring)	FXS Port
26	1	3
27	2	4
28	3	5
29	4	6
30	5	7
31	6	8
32	7	9
33	8	10
34	9	11
35	10	12
36	11	13
37	12	14
38	13	15
39	14	16
40	15	17
41	16	18
42	17	19
43	18	20
44	19	21
45	20	22
46	21	23
47	22	24
48	23	25
49	24	26
50	25	Not Used

THIS DOCUMENT IS PROVIDED TO YOU FOR INFORMATIONAL PURPOSES ONLY. The information furnished in this document, believed by Epygi Technologies to be accurate as of the date of publication, is subject to change without notice. Epygi Technologies assumes no responsibility for any errors or omissions in this document and shall have no obligation to you as a result of having made this document available to you or based upon the information it contains.

Epygi is a registered trademark of Epygi Technologies, Ltd. All other products and services are the registered trademarks of their respective holders.

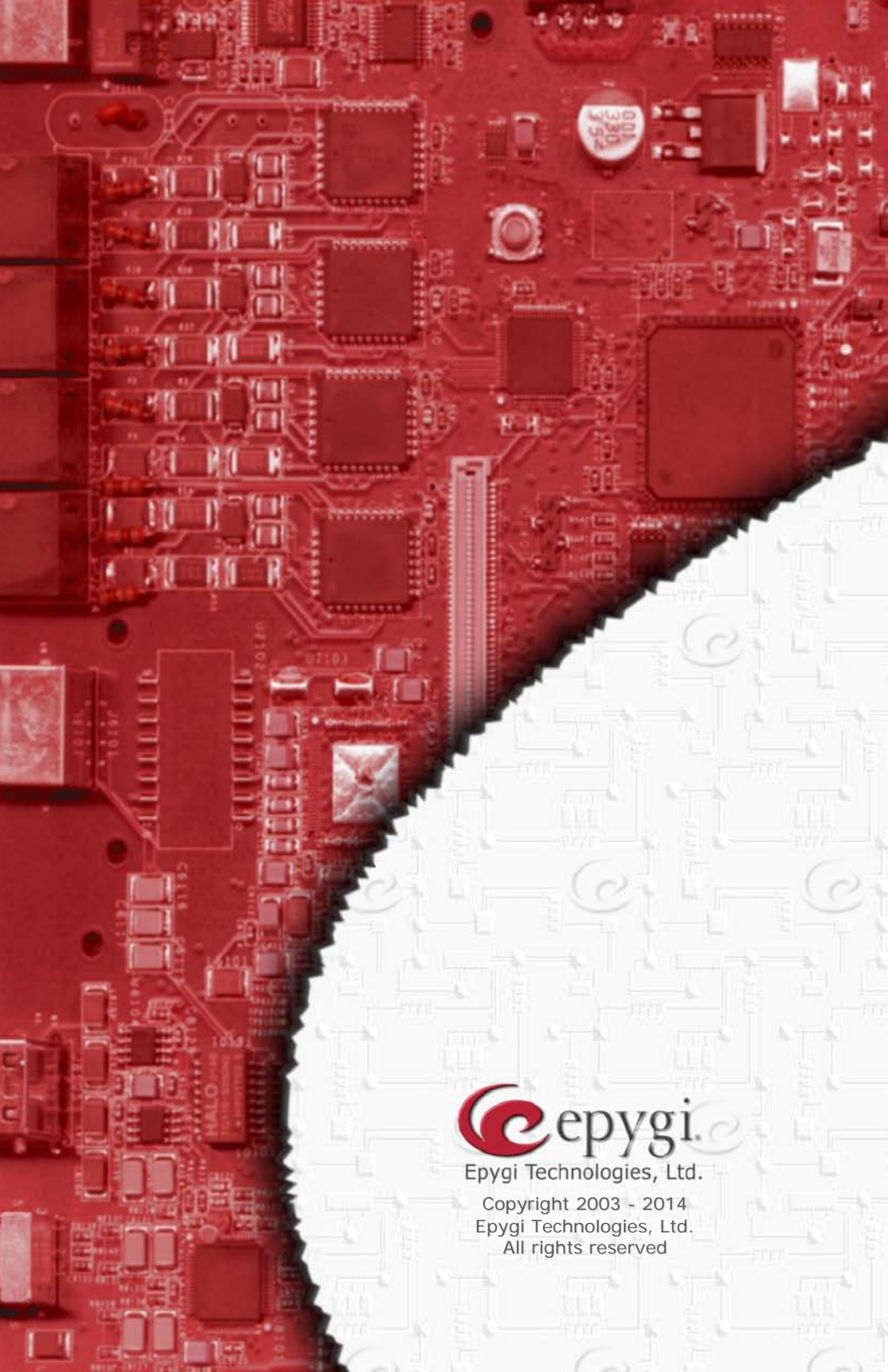

Epygi Technologies, Ltd.

Copyright 2003 - 2014
Epygi Technologies, Ltd.
All rights reserved